

# **USER MANUAL**

---

**SOLAR INVERTER/CHARGER**

**3.5KVA / 5.5KVA 230VAC**



# Table Of Contents

<b>ABOUT THIS MANUAL .....</b>	<b>1</b>
Purpose .....	1
Scope .....	1
<b>SAFETY INSTRUCTIONS .....</b>	<b>1</b>
<b>INTRODUCTION .....</b>	<b>2</b>
Features .....	2
Basic System Architecture .....	2
Product Overview .....	3
<b>INSTALLATION .....</b>	<b>4</b>
Unpacking and Inspection .....	4
Preparation .....	4
Mounting the Unit .....	4
Battery Connection .....	5
AC Input/Output Connection .....	6
PV Connection .....	8
Final Assembly .....	9
Dry Contact Signal .....	10
<b>OPERATION .....</b>	<b>11</b>
Power ON/OFF .....	11
Operation and Display Panel .....	11
LCD Display Icons .....	12
LCD Setting .....	14
Display Setting .....	22
Operating Mode Description .....	25
Fault Reference Code .....	28
Warning Indicator .....	29
<b>BATTERY EQUALIZATION .....</b>	<b>30</b>
<b>SETTING FOR LITHIUM BATTERY .....</b>	<b>32</b>
<b>SPECIFICATIONS .....</b>	<b>37</b>
Table 1 Line Mode Specifications .....	37
Table 2 Inverter Mode Specifications .....	38
Table 3 Charge Mode Specifications .....	39
Table 4 General Specifications .....	39
<b>TROUBLE SHOOTING .....</b>	<b>40</b>
<b>Parallel Installation Guide .....</b>	<b>41</b>
1. Instruction .....	41
2. Package Contents .....	41
3. Mounting the Unit .....	41
4. Wiring Connection .....	42
5. Parallel Operation in Single phase .....	44
6. Support 3-phase equipment .....	47
7. PV Connection .....	49
8. LCD Setting and Display .....	50
9. Commissioning .....	51
10. Trouble shooting .....	52
<b>WIFI Plug Pro Quick Installation Guide .....</b>	<b>53</b>

# ABOUT THIS MANUAL

## Purpose

This manual describes the assembly, installation, operation and troubleshooting of this unit. Please read this manual carefully before installations and operations. Keep this manual for future reference.

## Scope

This manual provides safety and installation guidelines as well as information on tools and wiring.

# SAFETY INSTRUCTIONS



**WARNING: This chapter contains important safety and operating instructions. Read and keep this manual for future reference.**

1. Before using the unit, read all instructions and cautionary markings on the unit, the batteries and all appropriate sections of this manual.
2. **CAUTION** --To reduce risk of injury, charge only deep-cycle lead acid type rechargeable batteries. Other types of batteries may burst, causing personal injury and damage.
3. Do not disassemble the unit. Take it to a qualified service center when service or repair is required. Incorrect re-assembly may result in a risk of electric shock or fire.
4. To reduce risk of electric shock, disconnect all wirings before attempting any maintenance or cleaning. Turning off the unit will not reduce this risk.
5. **CAUTION** – Only qualified personnel can install this device with battery.
6. **NEVER** charge a frozen battery.
7. For optimum operation of this inverter/charger, please follow required spec to select appropriate cable size. It's very important to correctly operate this inverter/charger.
8. Be very cautious when working with metal tools on or around batteries. A potential risk exists to drop a tool to spark or short circuit batteries or other electrical parts and could cause an explosion.
9. Please strictly follow installation procedure when you want to disconnect AC or DC terminals. Please refer to INSTALLATION section of this manual for the details.
10. Fuse is provided as over-current protection for the battery supply.
11. **GROUNDING INSTRUCTIONS** -This inverter/charger should be connected to a permanent grounded wiring system. Be sure to comply with local requirements and regulation to install this inverter.
12. **NEVER** cause AC output and DC input short circuited. Do NOT connect to the mains when DC input short circuits.
13. **Warning!!** Only qualified service persons are able to service this device. If errors still persist after following troubleshooting table, please send this inverter/charger back to local dealer or service center for maintenance.

# INTRODUCTION

This is a multi-function inverter/charger, combining functions of inverter, MPPT solar charger and battery charger to offer uninterruptible power support with portable size. Its comprehensive LCD display offers user-configurable and easy-accessible button operation such as battery charging current, AC/solar charger priority, and acceptable input voltage based on different applications.

## Features

- Pure sine wave inverter
- Inverter running without battery
- Built-in MPPT solar controller
- Configurable input voltage range for home appliances and personal computers via LCD setting
- Configurable battery charging current based on applications via LCD setting
- Configurable AC/Solar Charger priority via LCD setting
- Compatible to mains voltage or generator power
- Auto restart while AC is recovering
- Overload/ Over temperature/ short circuit protection
- Smart battery charger design for optimized battery performance
- Cold start function

## Basic System Architecture

The following illustration shows basic application for this inverter/charger. It also includes following devices to have a complete running system:

- Generator or Utility.
- PV modules (option)

Consult with your system integrator for other possible system architectures depending on your requirements.

This inverter can power all kinds of appliances in home or office environment, including motor-type appliances such as tube light, fan, refrigerator and air conditioner.

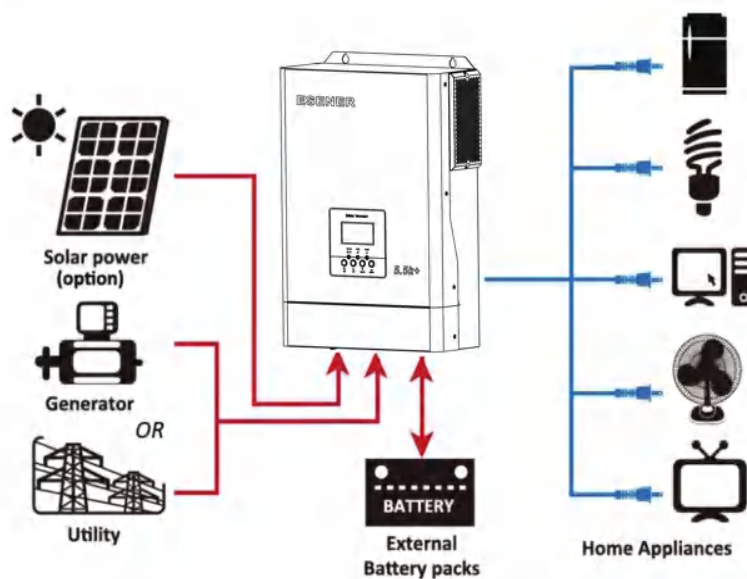
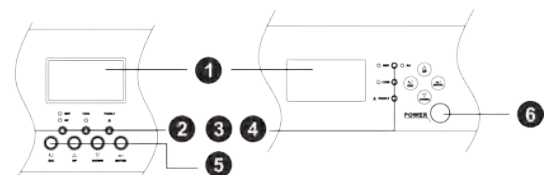
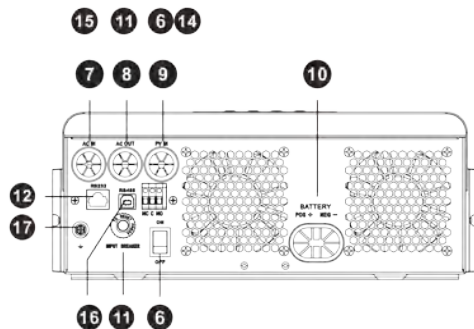
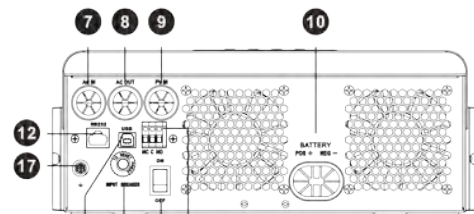
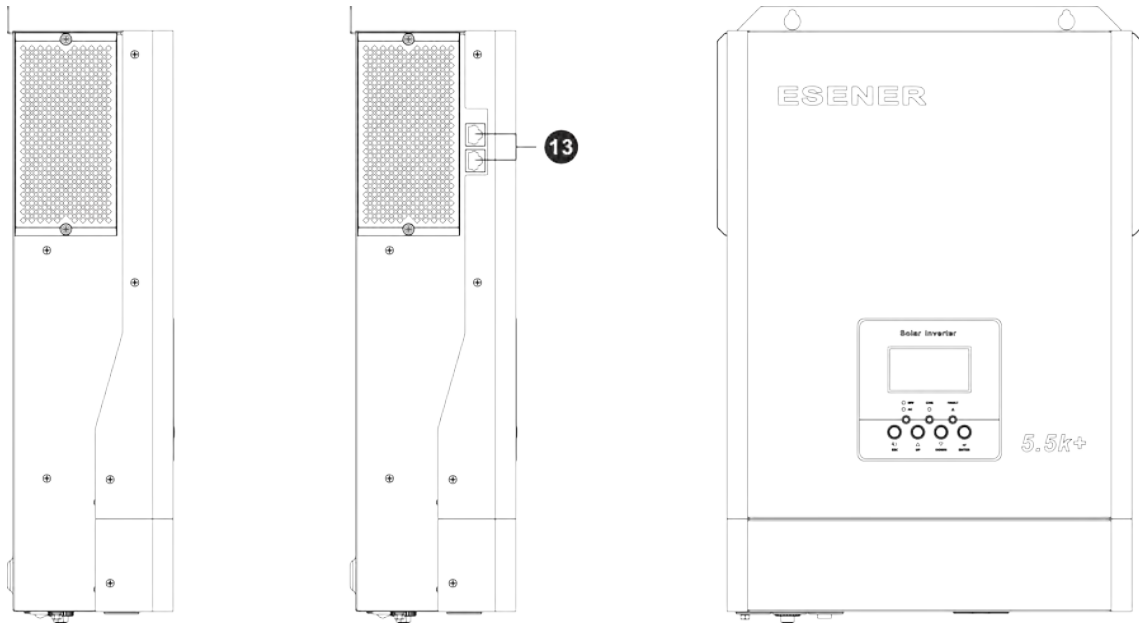

Figure 1 Hybrid Power System

## Product Overview



1. LCD display
2. Status indicator
3. Charging indicator
4. Fault indicator
5. Function buttons
6. Power on/off switch
7. AC input
8. AC output
9. PV input
10. Battery input
11. Circuit breaker
12. RS232 communication port
13. Parallel communication port  
(only for parallel model)
14. Dry contact (Optional)
15. USB communication port
16. RS485 communication port
17. Grounding

**NOTE:** For parallel model installation and operation, please check the parallel installation guide for the details.

# INSTALLATION

## Unpacking and Inspection

Before installation, please inspect the unit. Be sure that nothing inside the package is damaged. You should have received the following items inside of package:

- The unit x 1
- User manual x 1
- Wifi Communications Module x 1
- Battery BMS Cable x 2

## Preparation

Before connecting all wirings, please take off bottom cover by removing two screws as shown below.

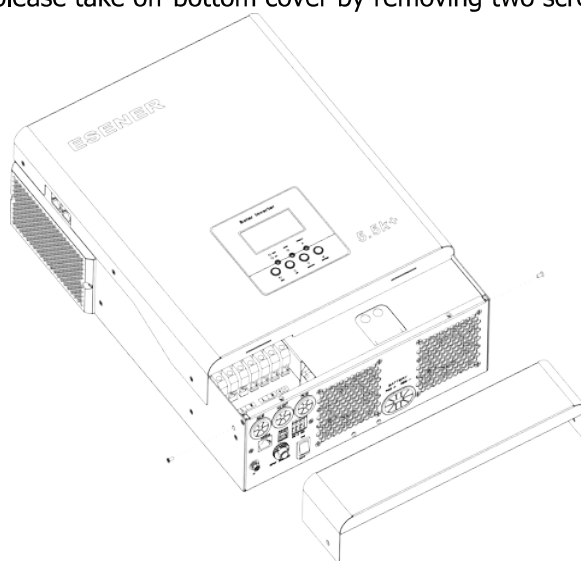

## Mounting the Unit

Consider the following points before selecting where to install:

- Do not mount the inverter on flammable construction materials.
- Mount on a solid surface
- Install this inverter at eye level in order to allow the LCD display to be read at all times.
- The ambient temperature should be between 0°C and 55°C to ensure optimal operation.
- The recommended installation position is to be adhered to the wall vertically.
- Be sure to keep other objects and surfaces as shown in the right diagram to guarantee sufficient heat dissipation and to have enough space for removing wires.

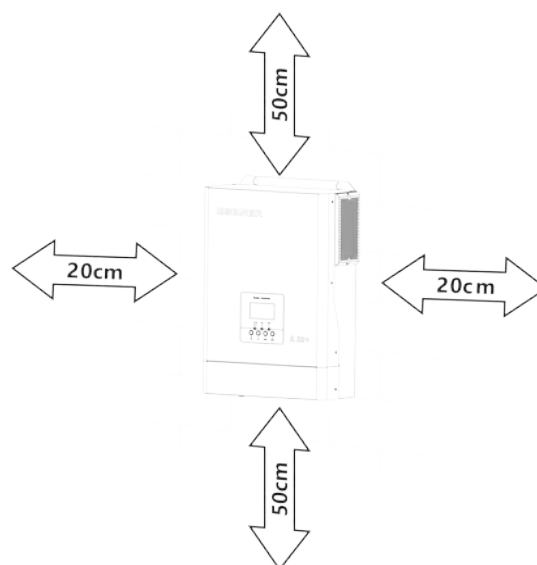

**SUITABLE FOR MOUNTING ON CONCRETE OR OTHER NON-COMBUSTIBLE SURFACE ONLY.**

Install the unit by screwing three screws. It's recommended to use M4 or M5 screws.

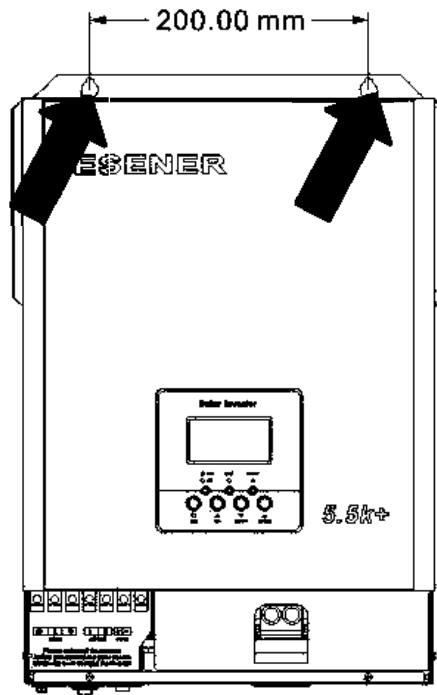

## Battery Connection

**CAUTION:** For safety operation and regulation compliance, it's requested to install a separate DC over-current protector or disconnect device between battery and inverter. It may not be requested to have a disconnect device in some applications, however, it's still requested to have over-current protection installed. Please refer to typical amperage in below table as required fuse or breaker size.

**WARNING!** All wiring must be performed by a qualified personnel.

**WARNING!** It's very important for system safety and efficient operation to use appropriate cable for battery connection. To reduce risk of injury, please use the proper recommended cable, stripping length(L2) and tinning length(L1) as below.

### Stripping Length:

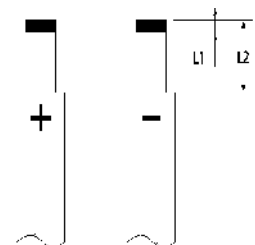

### Recommended battery cable, stripping length (L2) and tinning length(L1):

Model	Maximum Amperage	Battery capacity	Wire Size	Cable mm <sup>2</sup>	L1 (mm)	L 2 (mm)	Torque value
3.5KVA	137A	100AH	2AWG	38	3	18	2~ 3 Nm
5.5KVA	137A	200AH	2AWG	38	3	18	2~ 3 Nm

Please follow below steps to implement battery connection:

1. Remove insulation sleeve 18 mm for positive and negative cables based on recommended stripping length.
2. Connect all battery packs as units requires. It's suggested to use recommended battery capacity.
3. Insert battery cable flatly into battery connector of inverter and make sure the bolts are tightened with torque of 2-3 Nm. Make sure polarity at both the battery and the inverter/charge is correctly connected and battery cables are tightly screwed to the battery connector.



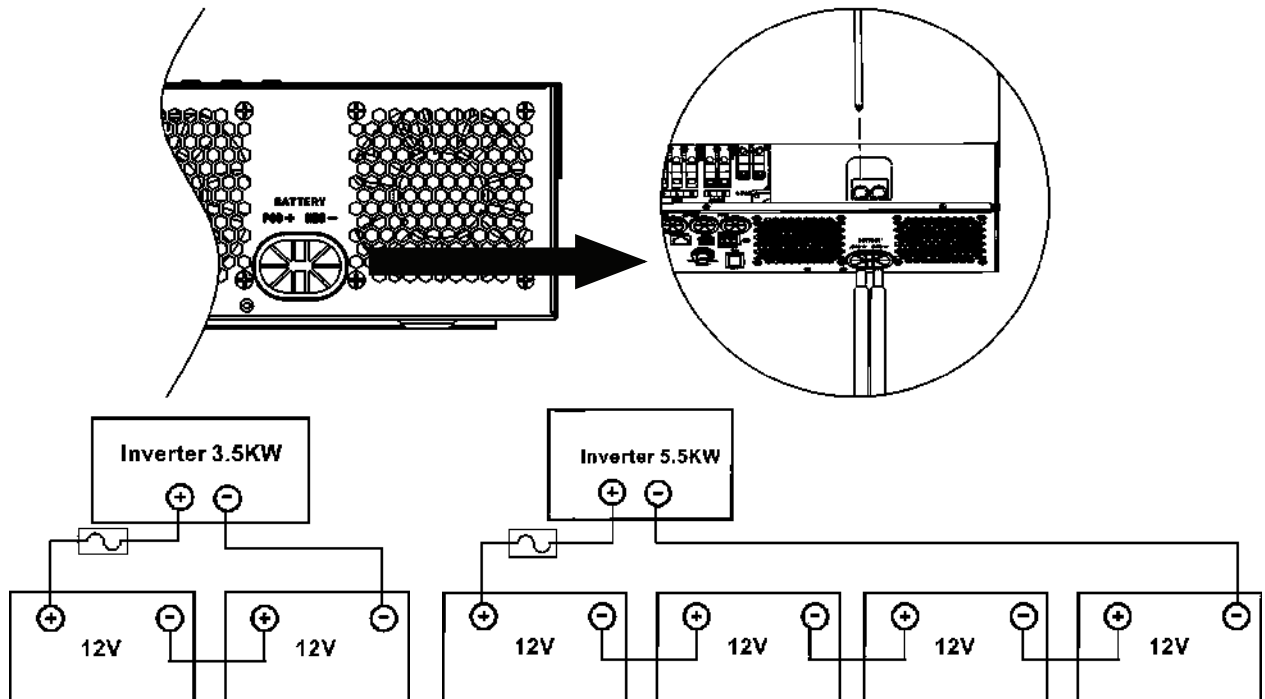

**⚠ WARNING: Shock Hazard**  
Installation must be performed with care due to high battery voltage in series.

**⚠ CAUTION!!** Do not place anything between the flat part of the inverter terminal. Otherwise, overheating may occur.  
**CAUTION!!** Do not apply anti-oxidant substance on the terminals before terminals are connected tightly.  
**CAUTION!!** Before making the final DC connection or closing DC breaker/disconnector, be sure positive (+) must be connected to positive (+) and negative (-) must be connected to negative (-).

## AC Input/Output Connection

**CAUTION!!** Before connecting to AC input power source, please install a **separate** AC breaker between inverter and AC input power source. This will ensure the inverter can be securely disconnected during maintenance and fully protected from over current of AC input. The recommended spec of AC breaker is 50A.

**CAUTION!!** There are two terminal blocks with "IN" and "OUT" markings. Please do NOT mis-connect input and output connectors.

**WARNING!** All wiring must be performed by a qualified personnel.

**WARNING!** It's very important for system safety and efficient operation to use appropriate cable for AC input connection. To reduce risk of injury, please use the proper recommended cable size as below.

### Suggested cable requirement for AC wires

Model	Gauge	Torque Value
3.5KVA	10AWG	1.4~ 1.6Nm
5.5KVA	8 AWG	1.4~ 1.6Nm

Please follow below steps to implement AC input/output connection:

1. Before making AC input/output connection, be sure to open DC protector or disconnector first.
2. Remove insulation sleeve 10mm for six conductors. And shorten phase L and neutral conductor N 3 mm.
3. Insert AC input wires according to polarities indicated on terminal block and tighten the terminal screws. Be sure to connect PE protective conductor (⊕) first.

⊕→Ground (yellow-green) L→LINE (brown or black) N→Neutral (blue)

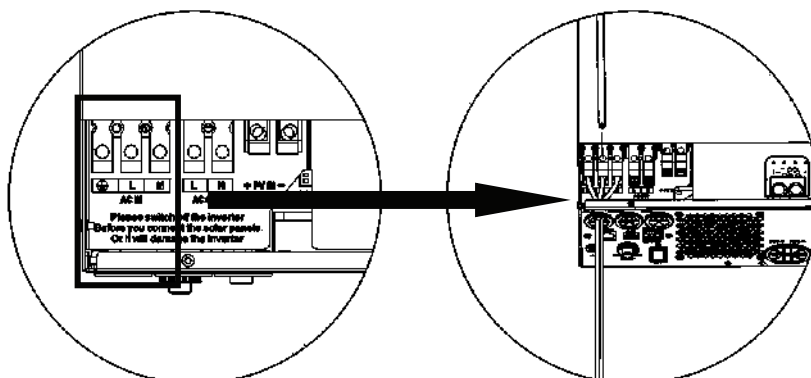

**WARNING:**

Be sure that AC power source is disconnected before attempting to hardwire it to the unit.

4. Then, insert AC output wires according to polarities indicated on terminal block and tighten terminal screws. Be sure to connect PE protective conductor (⊕) first.

⊕→Ground (yellow-green)

L→LINE (brown or black)

N→Neutral (blue)

**Note:Important**

- When the inverter is working in battery mode or standby mode, neutral of output is connected to grounding of AC output.
- When the inverter is working in AC mode, neutral of output is disconnected to grounding of AC output and connected to neural of AC input.

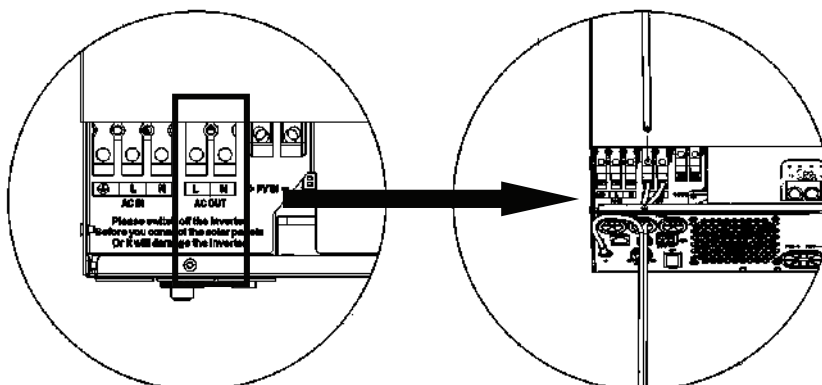

5. Make sure the wires are securely connected.

**CAUTION: Important**

Be sure to connect AC wires with correct polarity. If L and N wires are connected reversely, it may cause utility short-circuited when these inverters are worked in parallel operation.

**CAUTION:** Appliances such as air conditioner are required at least 2~3 minutes to restart because it's required to have enough time to balance refrigerant gas inside of circuits. If a power shortage occurs and recovers in a short time, it will cause damage to your connected appliances. To prevent this kind of damage, please check manufacturer of air conditioner if it's equipped with time-delay function before installation. Otherwise, this inverter/charger will trig overload fault and cut off output to protect your appliance but sometimes it still causes internal damage to the air conditioner.

## PV Connection

**CAUTION:** Before connecting to PV modules, please install **separately** a DC circuit breaker between inverter and PV modules.

**WARNING!** All wiring must be performed by a qualified personnel.

**WARNING!** It's very important for system safety and efficient operation to use appropriate cable for PV module connection. To reduce risk of injury, please use the proper recommended cable size as below.

Model	Typical Amperage	Cable Size	Torque
3.5KVA	15A	12 AWG	1.4~1.6 Nm
5.5KVA	18A	12 AWG	1.4~1.6 Nm

### PV Module Selection:

When selecting proper PV modules, please be sure to consider below parameters:

1. Open circuit Voltage (Voc) of PV modules not exceeds max. PV array open circuit voltage of inverter.
2. Open circuit Voltage (Voc) of PV modules should be higher than min. battery voltage.

Solar Charging Mode	
<b>INVERTER MODEL</b>	3.5KVA / 5.5KVA
<b>Max. PV Array Open Circuit Voltage</b>	500DC
<b>PV Array MPPT Voltage Range</b>	120VDC~450VDC

Take the 330Wp PV module as an example. After considering above two parameters, the recommended module configurations are listed in the table below.

Solar Panel Spec. (reference)	SOLAR INPUT	Q'ty of panels	Total input power	Inverter Model
	Min in serial: 6 pcs, max. in serial: 12 pcs			
- 330Wp	6 pcs in serial	6 pcs	1980W	3.5KVA/5.5KVA
- Vmp: 33.25Vdc	10 pcs in serial	10 pcs	3300W	3.5KVA/5.5KVA
- Imp: 9.925A	12 pcs in serial	12 pcs	3960W	3.5KVA/5.5KVA
- Voc: 40.35Vdc	6 pieces in serial and 2 sets in parallel	12 pcs	3960W	3.5KVA/5.5KVA
- Isc: 10.79A	8 pieces in serial and 2 sets in parallel	16 pcs	5280W	5.5KVA
- Cells: 60				

### PV Module Wire Connection:

Please follow below steps to implement PV module connection:

1. Remove insulation sleeve 10 mm for positive and negative conductors
2. Check correct polarity of connection cable from PV modules and PV input connectors. Then, connect positive pole (+) of connection cable to positive pole (+) of PV input connector. Connect negative pole (-) of connection cable to negative pole (-) of PV input connector.

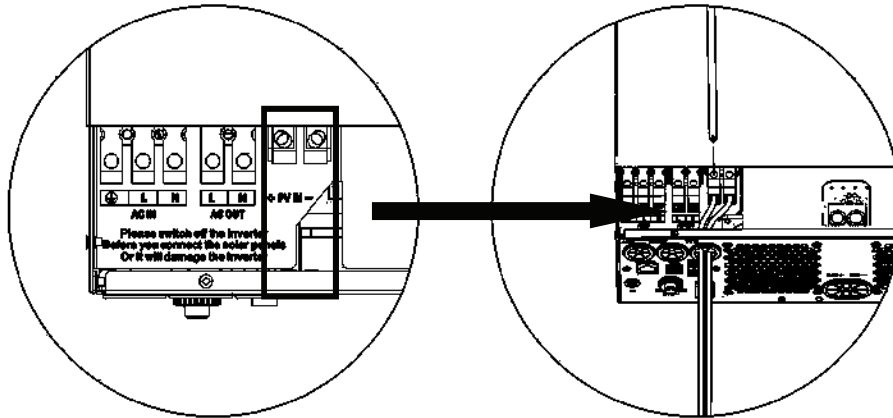
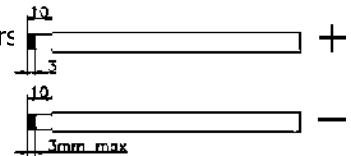

3. Make sure the wires are securely connected.

### Final Assembly

After connecting all wirings, please put bottom cover back by screwing two screws as shown below.

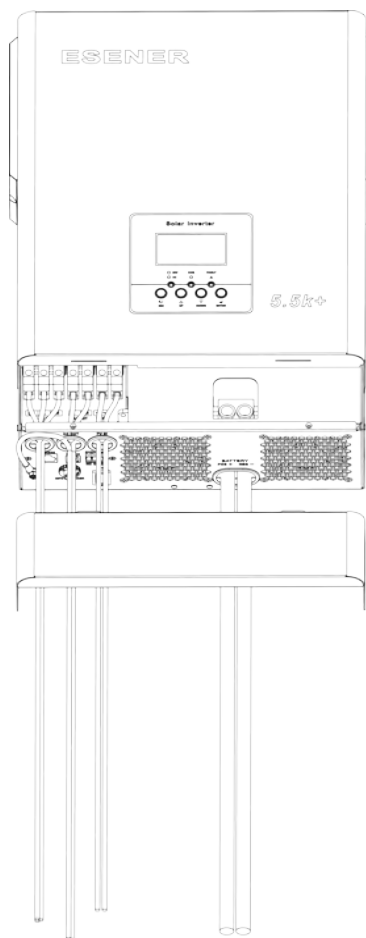

## Dry Contact Signal

There is one dry contact (3A/250VAC) available on the rear panel. It could be used to deliver signal to external device when battery voltage reaches warning level.

Unit Status	Condition		Dry contact port: 		
			NC & C	NO & C	
Power Off	Unit is off and no output is powered.		Close	Open	
Power On	Output is powered from Utility.		Close	Open	
	Output is powered from Battery or Solar.	Program 01 set as Utility	Battery voltage < Low DC warning voltage	Open	Close
		Program 01 set as SBU or SUB or Solar first	Battery voltage > Setting value in Program 13 or battery charging reaches floating stage	Close	Open
	Program 01 set as SBU or SUB or Solar first	Battery voltage < Setting value in Program 12	Open	Close	
Program 01 set as SBU or SUB or Solar first	Battery voltage > Setting value in Program 13 or battery charging reaches floating stage	Close	Open		

# OPERATION

## Power ON/OFF

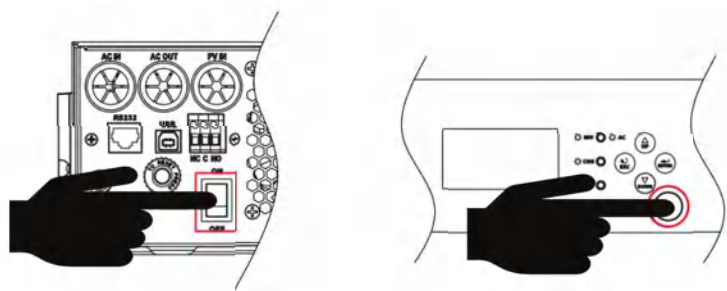

Once the unit has been properly installed and the batteries are connected well, simply press On/Off switch (located on the button of the case) to turn on the unit.

## Operation and Display Panel

The operation and display panel, shown in below chart, is on the front panel of the inverter. It includes three indicators, four function keys and a LCD display, indicating the operating status and input/output power information.

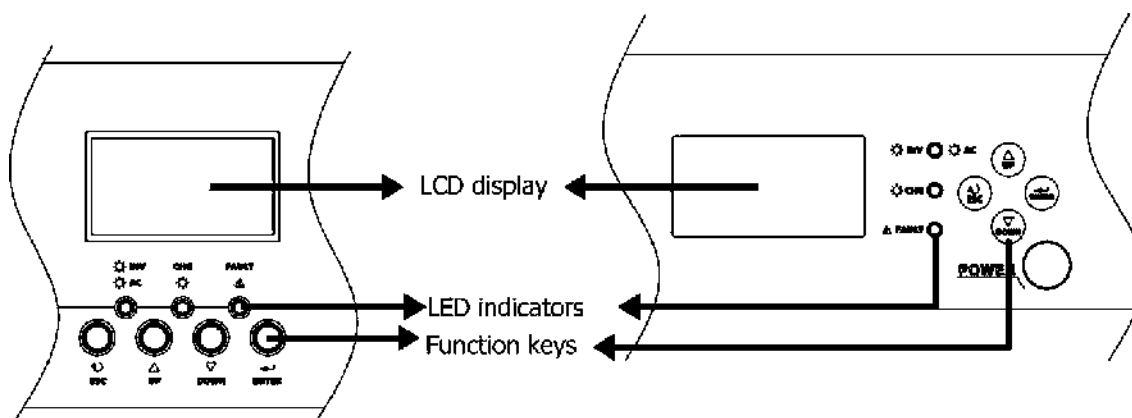

### LED Indicator

LED Indicator		Messages	
☀️ AC / ⚡️ INV	Green	Solid On	Output is powered by utility in Line mode.
		Flashing	Output is powered by battery or PV in battery mode.
🔋 CHG	Green	Solid On	Battery is fully charged.
		Flashing	Battery is charging.
⚠️ FAULT	Red	Solid On	Fault occurs in the inverter.
		Flashing	Warning condition occurs in the inverter.

### Function Keys

Function Key	Description
ESC	To exit setting mode
UP	To go to previous selection
DOWN	To go to next selection
ENTER	To confirm the selection in setting mode or enter setting mode

## LCD Display Icons

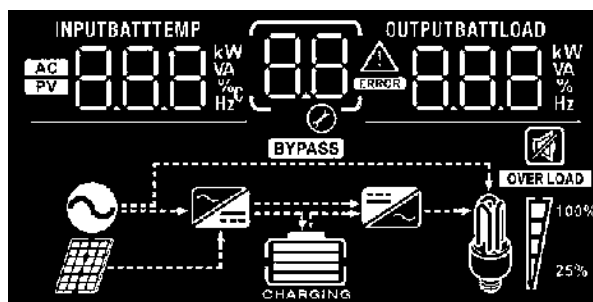

Icon	Function description
<b>Input Source Information</b>	
	Indicates the AC input.
	Indicates the PV input
	Indicate input voltage, input frequency, PV voltage, battery voltage and charger current.
<b>Configuration Program and Fault Information</b>	
	Indicates the setting programs.
	Warning:  flashing with warning code.
	Fault:  lighting with fault code
<b>Output Information</b>	
	Indicate output voltage, output frequency, load percent, load in VA, load in Watt and discharging current.
<b>Battery Information</b>	
	Indicates battery level by 0-24%, 25-49%, 50-74% and 75-100% in battery mode and charging status in line mode.

Load Information				
	Indicates overload.			
	Indicates the load level by 0-24%, 25-49%, 50-74% and 75-100%.			
	0%~24%	25%~49%	50%~74%	75%~100%
Mode Operation Information				
	Indicates unit connects to the mains.			
	Indicates unit connects to the PV panel.			
	Indicates load is supplied by utility power.			
	Indicates the utility charger circuit is working.			
	Indicates the DC/AC inverter circuit is working.			
Mute Operation				
	Indicates unit alarm is disabled.			



## LCD Setting

After pressing and holding ENTER button for 3 seconds, the unit will enter setting mode. Press "UP" or "DOWN" button to select setting programs. And then, press "ENTER" button to confirm the selection or ESC button to exit.

### Setting Programs:

Program	Description	Selectable option	
01	Output source priority: To configure load power source priority	Solar first 01 SOL	Solar energy provides power to the loads as first priority. If solar energy is not sufficient to power all connected loads, battery energy will supply power the loads at the same time. Utility provides power to the loads only when any one condition happens: - Solar energy is not available - Battery voltage drops to either low-level warning voltage or the setting point in program 12.
		Utility first (default) 01 UTI	Utility will provide power to the loads as first priority. Solar and battery energy will provide power to the loads only when utility power is not available.
		SBU priority 01 SBU	Solar energy provides power to the loads as first priority. If solar energy is not sufficient to power all connected loads, battery energy will supply power to the loads at the same time. Utility provides power to the loads only when battery voltage drops to either low-level warning voltage or the setting point in program 12.
		SUB priority 01 SUB	Solar energy is charged first and then power to the loads. If solar energy is not sufficient to power all connected loads, Utility energy will supply power to the loads at the same time.

02	Maximum charging current: To configure total charging current for solar and utility chargers. (Max. charging current = utility charging current + solar charging current)	10A 02 10 <sup>A</sup>	20A 02 20 <sup>A</sup>
		30A 02 30 <sup>A</sup>	40A 02 40 <sup>A</sup>
		50A 02 50 <sup>A</sup>	60A (default) 02 60 <sup>A</sup>
		70A 02 70 <sup>A</sup>	80A 02 80 <sup>A</sup>
03	AC input voltage range	Appliances (default) 03 APL	If selected, acceptable AC input voltage range will be within 90-280VAC.
		UPS 03 UPS	If selected, acceptable AC input voltage range will be within 170-280VAC.
		Generator 03 GNT	If selected, acceptable AC input voltage range will be within 170-280VAC and compatible with generators.  Note: Because generators are unstable, maybe the output of inverter will be unstable too.
04	Power saving mode enable/disable	Saving mode disable (default) 04 SdS	If disabled, no matter connected load is low or high, the on/off status of inverter output will not be effected.
		Saving mode enable 04 SEN	If enabled, the output of inverter will be off when connected load is pretty low or not detected.
05	Battery type	AGM (default) 05 AGM	Flooded 05 FLD
		User-Defined 05 USE	If "User-Defined" is selected, battery charge voltage and low DC cut-off voltage can be set up in program 26, 27 and 29.
06	Auto restart when overload occurs	Restart disable (default) 06 LTD	Restart enable 06 LFE
07	Auto restart when over temperature occurs	Restart disable (default) 07 LTD	Restart enable 07 LFE





08	Output voltage	220V 08 220 <sup>v</sup>	230V (default) 08 230 <sup>v</sup>
		240V 08 240 <sup>v</sup>	
09	Output frequency	50Hz (default) 09 50 <sup>Hz</sup>	60Hz 09 60 <sup>Hz</sup>
10	Auto bypass When selecting "auto", if the mains power is normal, it will automatically bypass, even if the switch is off.	manual(default) 10 nNL	auto 10 Ato
11	Maximum utility charging current	2A 11 2A	10A 11 10A
		20A 11 20A	30A (default) 11 30A
		40A 11 40A	50A 11 50A
		60A 11 60A	70A 11 70A
		80A 11 80A	
12	Setting voltage point back to utility source when selecting "SBU priority" or "Solar first" in program 01.	Available options in 48V models: Setting range is from 44.0V to 57.2V for 48v model, but The max setting value must be less than the value of program13.	
		44V 12 44.0 <sup>v</sup> BATT	45V 12 45.0 <sup>v</sup> BATT
		46V (default) 12 46.0 <sup>v</sup> BATT	47V 12 47.0 <sup>v</sup> BATT
		48V 12 48.0 <sup>v</sup> BATT	49V 12 49.0 <sup>v</sup> BATT
		50V 12 50.0 <sup>v</sup> BATT	51V 12 51.0 <sup>v</sup> BATT
		52V 12 52.0 <sup>v</sup> BATT	53V 12 53.0 <sup>v</sup> BATT
		54V 12 54.0 <sup>v</sup> BATT	55V 12 55.0 <sup>v</sup> BATT

		<p>Available options in 24V models: Setting range is from 22.0V to 28.6V for 24v model, but The max setting value must be less than the value of program13.</p>																
		<table border="1"> <tr> <td>22 V 12 <sup>BATT</sup> 22.0 v</td> <td>23V (default) 12 <sup>BATT</sup> 23.0 v</td> <td>24 V 12 <sup>BATT</sup> 24.0 v</td> </tr> <tr> <td>25 V 12 <sup>BATT</sup> 25.0 v</td> <td>26V 12 <sup>BATT</sup> 26.0 v</td> <td>27 V 12 <sup>BATT</sup> 27.0 v</td> </tr> </table>	22 V 12 <sup>BATT</sup> 22.0 v	23V (default) 12 <sup>BATT</sup> 23.0 v	24 V 12 <sup>BATT</sup> 24.0 v	25 V 12 <sup>BATT</sup> 25.0 v	26V 12 <sup>BATT</sup> 26.0 v	27 V 12 <sup>BATT</sup> 27.0 v										
22 V 12 <sup>BATT</sup> 22.0 v	23V (default) 12 <sup>BATT</sup> 23.0 v	24 V 12 <sup>BATT</sup> 24.0 v																
25 V 12 <sup>BATT</sup> 25.0 v	26V 12 <sup>BATT</sup> 26.0 v	27 V 12 <sup>BATT</sup> 27.0 v																
13	Setting voltage point back to battery mode when selecting "SBU priority" or "Solar first" in program 01.	<p>Available options in 48V models: Setting range is from 48V to full (the value of program26-0.4V), but the max setting value must be more than the value of program12.</p> <table border="1"> <tr> <td>Battery fully charged (default) 13 <sup>BATT</sup> FUL</td> <td>48V 13 <sup>BATT</sup> 48.0 v</td> </tr> <tr> <td>49V 13 <sup>BATT</sup> 49.0 v</td> <td>50V 13 <sup>BATT</sup> 50.0 v</td> </tr> <tr> <td>51V 13 <sup>BATT</sup> 51.0 v</td> <td>52V 13 <sup>BATT</sup> 52.0 v</td> </tr> <tr> <td>53V 13 <sup>BATT</sup> 53.0 v</td> <td>54V 13 <sup>BATT</sup> 54.0 v</td> </tr> <tr> <td>55V 13 <sup>BATT</sup> 55.0 v</td> <td>56V 13 <sup>BATT</sup> 56.0 v</td> </tr> <tr> <td>57V 13 <sup>BATT</sup> 57.0 v</td> <td>58V 13 <sup>BATT</sup> 58.0 v</td> </tr> <tr> <td>59V 13 <sup>BATT</sup> 59.0 v</td> <td>60V 13 <sup>BATT</sup> 60.0 v</td> </tr> <tr> <td>61V 13 <sup>BATT</sup> 61.0 v</td> <td>62V 13 <sup>BATT</sup> 62.0 v</td> </tr> </table>	Battery fully charged (default) 13 <sup>BATT</sup> FUL	48V 13 <sup>BATT</sup> 48.0 v	49V 13 <sup>BATT</sup> 49.0 v	50V 13 <sup>BATT</sup> 50.0 v	51V 13 <sup>BATT</sup> 51.0 v	52V 13 <sup>BATT</sup> 52.0 v	53V 13 <sup>BATT</sup> 53.0 v	54V 13 <sup>BATT</sup> 54.0 v	55V 13 <sup>BATT</sup> 55.0 v	56V 13 <sup>BATT</sup> 56.0 v	57V 13 <sup>BATT</sup> 57.0 v	58V 13 <sup>BATT</sup> 58.0 v	59V 13 <sup>BATT</sup> 59.0 v	60V 13 <sup>BATT</sup> 60.0 v	61V 13 <sup>BATT</sup> 61.0 v	62V 13 <sup>BATT</sup> 62.0 v
Battery fully charged (default) 13 <sup>BATT</sup> FUL	48V 13 <sup>BATT</sup> 48.0 v																	
49V 13 <sup>BATT</sup> 49.0 v	50V 13 <sup>BATT</sup> 50.0 v																	
51V 13 <sup>BATT</sup> 51.0 v	52V 13 <sup>BATT</sup> 52.0 v																	
53V 13 <sup>BATT</sup> 53.0 v	54V 13 <sup>BATT</sup> 54.0 v																	
55V 13 <sup>BATT</sup> 55.0 v	56V 13 <sup>BATT</sup> 56.0 v																	
57V 13 <sup>BATT</sup> 57.0 v	58V 13 <sup>BATT</sup> 58.0 v																	
59V 13 <sup>BATT</sup> 59.0 v	60V 13 <sup>BATT</sup> 60.0 v																	
61V 13 <sup>BATT</sup> 61.0 v	62V 13 <sup>BATT</sup> 62.0 v																	

		Available options in 24V models: Setting range is from 24V to full (the value of program26-0.4V), but the max setting value must be more than the value of program12.	
	Battery fully charged (default)	24V 13 <sup>BATT</sup> FUL 13 <sup>BATT</sup> 24.0 <sub>v</sub>	
	25V	26V 13 <sup>BATT</sup> 25.0 <sub>v</sub> 13 <sup>BATT</sup> 26.0 <sub>v</sub>	
	27V (default)	28V 13 <sup>BATT</sup> 27.0 <sub>v</sub> 13 <sup>BATT</sup> 28.0 <sub>v</sub>	
	29v	30v 13 <sup>BATT</sup> 29.0 <sub>v</sub> 13 <sup>BATT</sup> 30.0 <sub>v</sub>	
16	Charger source priority: To configure charger source priority	If this inverter/charger is working in Line, Standby or Fault mode, charger source can be programmed as below:	
		Solar first 16 <sup>CS0</sup>	Solar energy will charge battery as first priority. Utility will charge battery only when solar energy is not available.
		Utility first 16 <sup>CUT</sup>	Utility will charge battery as first priority. Solar energy will charge battery only when utility power is not available.
		Solar and Utility (default) 16 <sup>SNU</sup>	Solar energy and utility will charge battery at the same time.
		Only Solar 16 <sup>OSO</sup>	Solar energy will be the only charger source no matter utility is available or not.
		If this inverter/charger is working in Battery mode or Power saving mode, only solar energy can charge battery. Solar energy will charge battery if it's available and sufficient.	

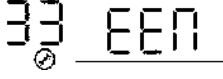
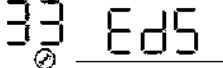
18	Buzzer mode	Mode1 BU2 18 nd1	Buzzer mute
		Mode2 BU2 18 nd2	The buzzer sounds when the input source changes or there is a specific warning or fault
		Mode3 BU2 18 nd3	The buzzer sounds when there is a specific warning or fault
		Mode4(default) BU2 18 nd4	The buzzer sounds when there is a fault
19	Auto return to default display screen	Return to default display screen (default) 19 ESP	If selected, no matter how users switch display screen, it will automatically return to default display screen (Input voltage /output voltage) after no button is pressed for 1 minute.
		Stay at latest screen 19 LEP	If selected, the display screen will stay at latest screen user finally switches.
20	Backlight control	Backlight on (default) 20 LON	Backlight off 20 LOF
23	Overload bypass: When enabled, the unit will transfer to line mode if overload occurs in battery mode.	Bypass disable (default) 23 byd	Bypass enable 23 byE
25	Modbus ID Setting	Modbus ID Setting Range : 001(default)~247 n0d 25 001	
26	Bulk charging voltage (C.V voltage)	48V models default setting: 56.4V CU 26 56.4 <sup>BATT</sup> v	
		24V models default setting: 28.2V CU 26 28.2 <sup>BATT</sup> v	
		If self-defined is selected in program 5, this program can be set up. Setting range is from 24.0V to 31.0V for 24v model and 48.0V to 62.0V for 48v model. But the setting value must be more than or equal the value of program27. Increment of each click is 0.1V.	
27	Floating charging voltage	48V models default setting: 54.0V FLU 27 54.0 <sup>BATT</sup> v	

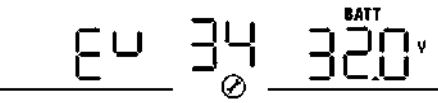
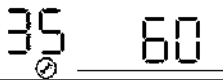
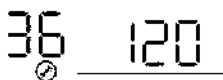
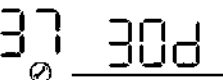
		<p>24V models default setting: 27.0V</p> <p>FLV 27 <sup>BATT</sup> 27.0<sub>v</sub></p> <p>If self-defined is selected in program 5, this program can be set up. Setting range is from 24.0V to the value of program 26 for 24v model and 48.0V to the value of program 26 for 48v model. Increment of each click is 0.1V.</p>	
28	AC output mode	<p>Single: This inverter is used in single phase application.</p> <p>28 510</p>	<p>Parallel: This inverter is operated in parallel system. (Need hardware support)</p> <p>28 PAL</p>
		<p>L1 phase</p> <p>28 3P1</p>	The inverter is operated in L1 phase in 3-phase application
		<p>L2 phase</p> <p>28 3P2</p>	The inverter is operated in L2 phase in 3-phase application
		<p>L3 phase</p> <p>28 3P3</p>	The inverter is operated in L3 phase in 3-phase application
29	Low DC cut-off voltage	<p>48V models default setting: 42.0V</p> <p>COV 29 <sup>BATT</sup> 42.0<sub>v</sub></p>	
		<p>24V models default setting: 21.0v</p> <p>COV 29 <sup>BATT</sup> 21.0<sub>v</sub></p>	
		<p>If self-defined is selected in program 5, this program can be set up. Setting range is from 20.0V to 27.0V for 24v model and 40.0V to 54.0V for 48v model. The setting value must be less than the value of program12. Increment of each click is 0.1V.Low DC cut-off voltage will be fixed to setting value no matter what percentage of load is connected.</p>	
32	Bulk charging time (C.V stage)	<p>Automatically (Default):</p> <p>32 AUT</p>	If selected, inverter will judge this charging time automatically.
		<p>5 min</p> <p>32 5</p>	The setting range is from 5 min to 900 min. Increment of each click is 5 min.
		<p>900 min</p> <p>32 900</p>	
		<p>If "USE" is selected in program 05, this program can be set up.</p>	

33	Battery equalization	Battery equalization 	Battery equalization disable (default) 
If "Flooded" or "User-Defined" is selected in program 05, this program can be set up.			
34	Battery equalization voltage	48V models default setting is 58.4V. Setting range is from 48V ~ 64V. Increment of each click is 0.1V. 	
		24V models default setting is 29.2V. Setting range is from 24V ~ 32V. Increment of each click is 0.1V. 	
35	Battery equalized time	60min (default) 	Setting range is from 5min to 900min. Increment of each click is 5min.
36	Battery equalized timeout	120min (default) 	Setting range is from 5min to 900 min. Increment of each click is 5 min.
37	Equalization interval	30days (default) 	Setting range is from 0 to 90 days. Increment of each click is 1 day
39	Equalization activated immediately	Enable 	Disable (default) 
If equalization function is enabled in program 33, this program can be set up. If "Enable" is selected in this program, it's to activate battery equalization immediately and LCD main page will shows "E9". If "Disable" is selected, it will cancel equalization function until next activated equalization time arrives based on program 37 setting. At this time, "E9" will not be shown in LCD main page.			



## Display Setting

The LCD display information will be switched in turns by pressing "UP" or "DOWN" key. The selectable information is switched as below order: input voltage, input frequency, PV voltage, MPPT charging current, MPPT charging power, charging current, charging power, battery voltage, output voltage, output frequency, load percentage, load in VA, load in Watt, DC discharging current, main CPU Version and second CPU Version.



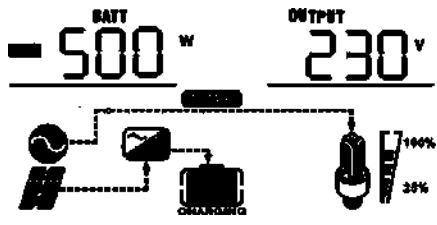
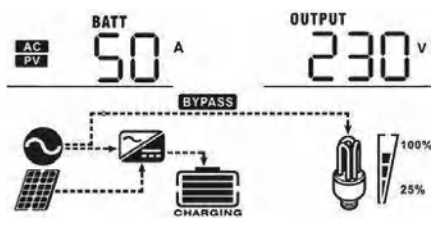
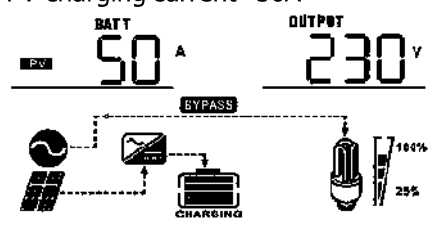
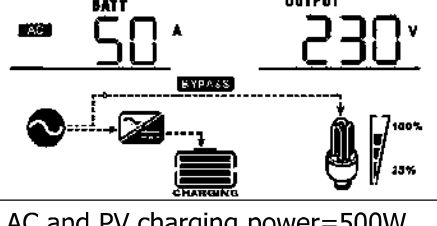
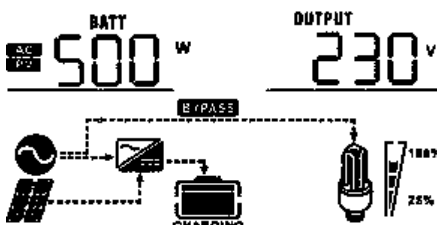
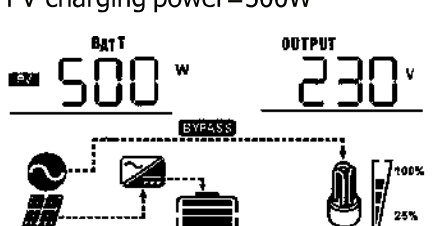
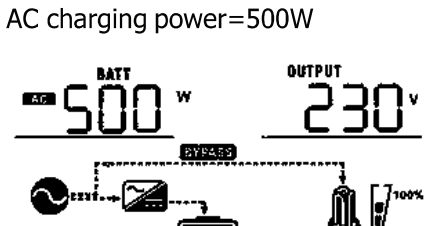

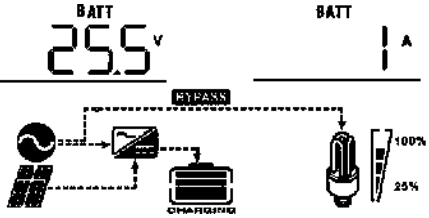
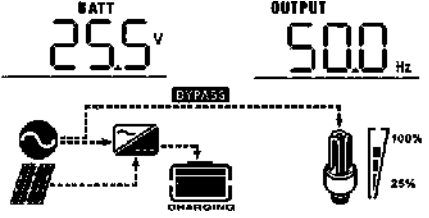
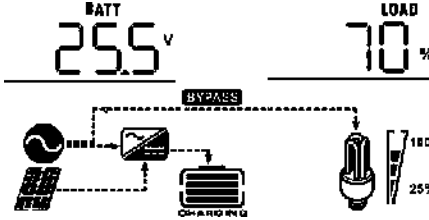
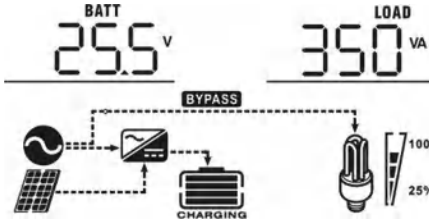
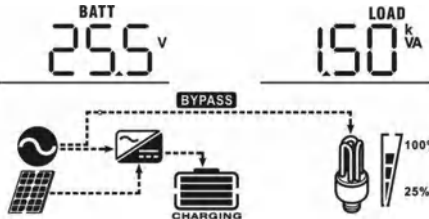
Selectable information	LCD display
Input voltage/Output voltage (Default Display Screen)	<p>Input Voltage=230V, output voltage=230V</p>
Input frequency	<p>Input frequency=50Hz</p>
PV voltage	<p>PV voltage=200V</p>
MPPT Charging current	<p>Current <math>\geq 10A</math></p> <p>Current &lt; 10A</p>

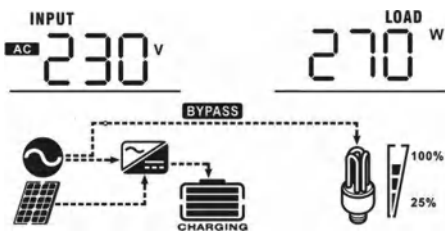
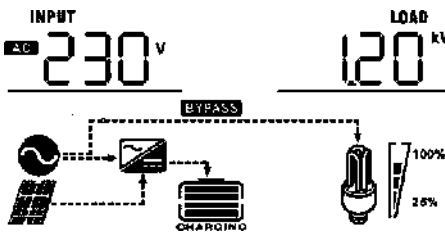



<p>MPPT Charging power</p>	<p>MPPT charging power=500W</p>  <p>The diagram shows a digital display with 'BATT' and '500 W' on the left, and 'OUTPUT' and '230 V' on the right. Below the display is a schematic showing a solar panel connected to a battery, which is being charged. A 'CHARGING' indicator is shown. To the right, a light bulb is shown with a meter indicating 100% and 25%.</p>
<p>Charging current</p>	<p>AC and PV charging current=50A</p>  <p>The diagram shows a digital display with 'AC' and 'PV' indicators, 'BATT' and '50 A' on the left, and 'OUTPUT' and '230 V' on the right. Below the display is a schematic showing a solar panel connected to a battery, which is being charged. A 'CHARGING' indicator is shown. To the right, a light bulb is shown with a meter indicating 100% and 25%.</p> <p>PV charging current=50A</p>  <p>The diagram shows a digital display with 'PV' indicator, 'BATT' and '50 A' on the left, and 'OUTPUT' and '230 V' on the right. Below the display is a schematic showing a solar panel connected to a battery, which is being charged. A 'CHARGING' indicator is shown. To the right, a light bulb is shown with a meter indicating 100% and 25%.</p> <p>AC charging current=50A</p>  <p>The diagram shows a digital display with 'AC' indicator, 'BATT' and '50 A' on the left, and 'OUTPUT' and '230 V' on the right. Below the display is a schematic showing an AC source connected to a battery, which is being charged. A 'CHARGING' indicator is shown. To the right, a light bulb is shown with a meter indicating 100% and 25%.</p>
<p>Charging power</p>	<p>AC and PV charging power=500W</p>  <p>The diagram shows a digital display with 'AC' and 'PV' indicators, 'BATT' and '500 W' on the left, and 'OUTPUT' and '230 V' on the right. Below the display is a schematic showing a solar panel connected to a battery, which is being charged. A 'CHARGING' indicator is shown. To the right, a light bulb is shown with a meter indicating 100% and 25%.</p> <p>PV charging power=500W</p>  <p>The diagram shows a digital display with 'PV' indicator, 'BATT' and '500 W' on the left, and 'OUTPUT' and '230 V' on the right. Below the display is a schematic showing a solar panel connected to a battery, which is being charged. A 'CHARGING' indicator is shown. To the right, a light bulb is shown with a meter indicating 100% and 25%.</p> <p>AC charging power=500W</p>  <p>The diagram shows a digital display with 'AC' indicator, 'BATT' and '500 W' on the left, and 'OUTPUT' and '230 V' on the right. Below the display is a schematic showing an AC source connected to a battery, which is being charged. A 'CHARGING' indicator is shown. To the right, a light bulb is shown with a meter indicating 100% and 25%.</p>



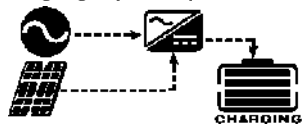

<p>Battery voltage/ DC discharging current</p>	<p>Battery voltage=25.5V, discharging current=1A</p> 
<p>Output frequency</p>	<p>Output frequency=50Hz</p> 
<p>Load percentage</p>	<p>Load percent=70%</p> 
<p>Load in VA</p>	<p>When connected load is lower than 1kVA, load in VA will present xxxVA like below chart.</p>  <p>When load is larger than 1kVA (<math>\geq 1\text{kVA}</math>), load in VA will present x.xkVA like below chart.</p> 

<p>Load in Watt</p>	<p>When load is lower than 1kW, load in W will present xxxW like below chart.</p>  <p>When load is larger than 1kW (<math>\geq 1\text{KW}</math>), load in W will present x.xkW like below chart.</p> 
---------------------	--

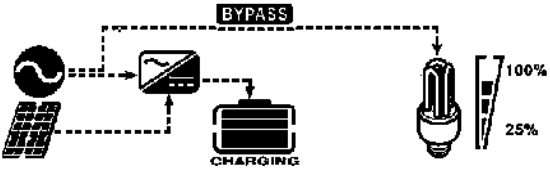
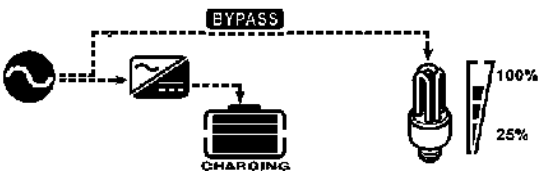
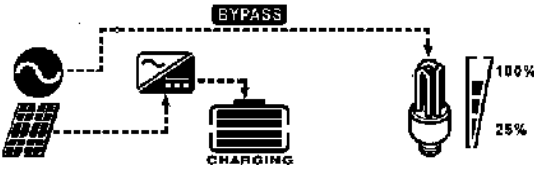

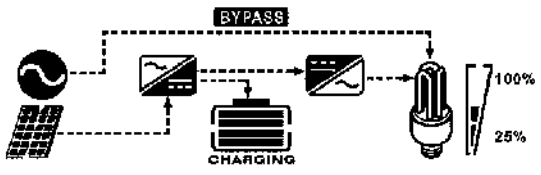
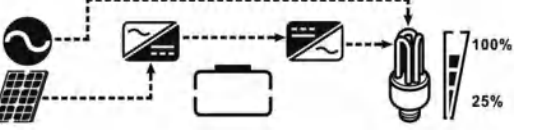
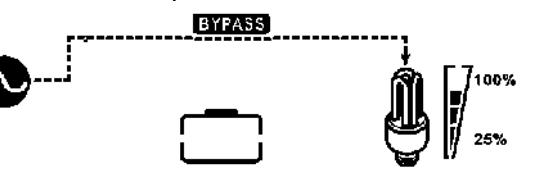

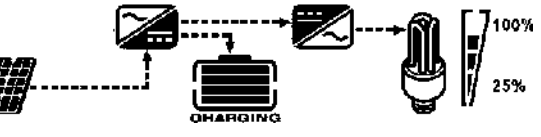

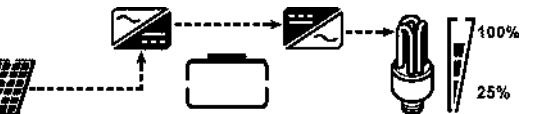















## Operating Mode Description

Operation mode	Description	LCD display
<p>Standby mode / Power saving mode</p> <p><b>Note:</b></p> <p>*Standby mode: The inverter is not turned on yet but at this time, the inverter can charge battery without AC output.</p> <p>*Power saving mode: If enabled, the output of inverter will be off when connected load is pretty low or not detected.</p>	<p>No output is supplied by the unit but it still can charge batteries.</p>	<p>Charging by utility and PV energy.</p> 
		<p>Charging by utility.</p> 
		<p>Charging by PV energy.</p> 
		<p>No charging.</p> 

<p>Fault mode Note: *Fault mode: Errors are caused by inside circuit error or external reasons such as over temperature, output short circuited and so on.</p>	<p>PV energy and utility can charge batteries.</p>	<p>Charging by utility and PV energy.</p> 
		<p>Charging by utility.</p> 
		<p>Charging by PV energy.</p> 
		<p>No charging.</p> 
<p>Line Mode</p>	<p>The unit will provide output power from the mains. It will also charge the battery at line mode.</p>	<p>Charging by utility and PV energy.</p> 
	<p>The unit will provide output power from the mains. It will also charge the battery at line mode.</p>	<p>Charging by utility.</p> 
	<p>The unit will provide output power from the mains. It will also charge the battery at line mode.</p>	<p>If "solar first" is selected as output source priority and solar energy is not sufficient to provide the load, solar energy and the utility will provide the loads and charge the battery at the same time.</p> 

	<p>The unit will provide output power from the mains. It will also charge the battery at line mode.</p>	<p>if "SUB" is selected as output source priority and battery is connected, solar energy will charge battery as first priority.</p> <p>if solar energy is sufficient for charging, solar and the utility will provide the loads.</p> 
<p>Line Mode</p>	<p>The unit will provide output power from the mains.</p>	<p>If "solar first" is selected as output source priority and battery is not connected, solar energy and the utility will provide the loads.</p>  <p>Power from utility.</p> 
<p>Battery Mode</p>	<p>The unit will provide output power from battery and PV power.</p>	<p>Power from battery and PV energy.</p>  <p>PV energy will supply power to the loads and charge battery at the same time</p>  <p>Power from battery only.</p>  <p>Power from PV energy only.</p> 

## Fault Reference Code

Fault Code	Fault Event	Icon on
01	Over temperature of inverter module	
02	Over temperature of DCDC module	
03	Battery voltage is too high	
04	Over temperature of PV module	
05	Output short circuited.	
06	Output voltage is too high.	
07	Overload time out	
08	Bus voltage is too high	
09	Bus soft start failed	
10	PV over current	
11	PV over voltage	
12	DCDC over current	
13	Over current or surge	
14	Bus voltage is too low	
15	Inverter failed (Self-checking)	
16	Over DC voltage in AC output	
17	Reserved	
18	Op current offset is too high	
19	Inverter current offset is too high	
20	DC/DC current offset is too high	
21	PV current offset is too high	
22	Output voltage is too low	
23	Inverter negative power	

## Warning Indicator

Warning Code	Warning Event	Audible Alarm	Icon flashing
02	Temperature is too High	Beep three times every second	
04	Low battery	Beep once every second	
07	Overload	Beep once every 0.5 second	
10	Output power derating	Beep twice every 3 seconds	
15	PV energy is low	Beep twice every 3 seconds	
19	Lithium Battery communication is failed	Beep once every 0.5 second	
20	Battery low and it isn't up to the setting value of program 13	Beep twice every 3 seconds	
E9	Battery equalization	None	
bP	Battery is not connected	None	



# BATTERY EQUALIZATION

Equalization function is added into charge controller. It reverses the buildup of negative chemical effects like stratification, a condition where acid concentration is greater at the bottom of the battery than at the top. Equalization also helps to remove sulfate crystals that might have built up on the plates. If left unchecked, this condition, called sulfation, will reduce the overall capacity of the battery. Therefore, it's recommended to equalize battery periodically.

- **How to Apply Equalization Function**

You must enable battery equalization function in monitoring LCD setting program 33 first. Then, you may apply this function in device by either one of following methods:

1. Setting equalization interval in program 37.
2. Active equalization immediately in program 39.

- **When to Equalize**

In float stage, when the setting equalization interval (battery equalization cycle) is arrived, or equalization is active immediately, the controller will start to enter Equalize stage.

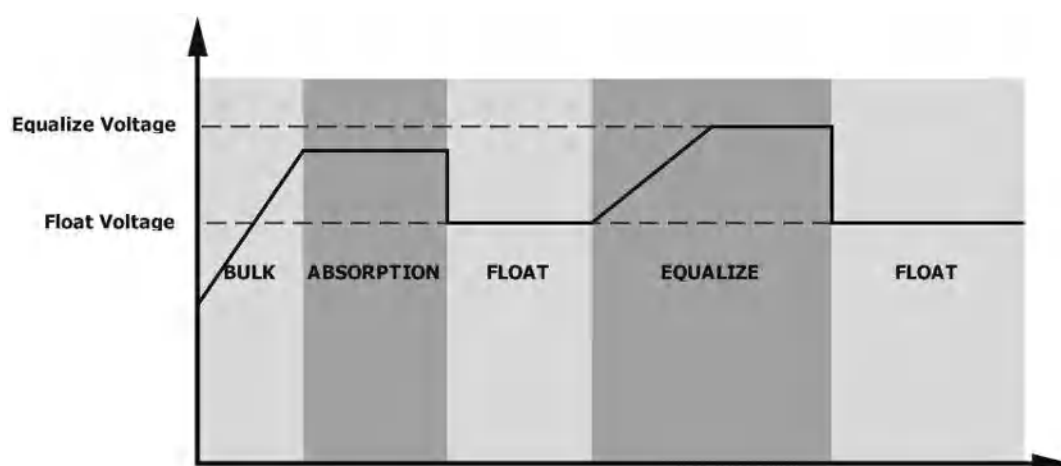

- **Equalize charging time and timeout**

In Equalize stage, the controller will supply power to charge battery as much as possible until battery voltage raises to battery equalization voltage. Then, constant-voltage regulation is applied to maintain battery voltage at the battery equalization voltage. The battery will remain in the Equalize stage until setting battery equalized time is arrived.

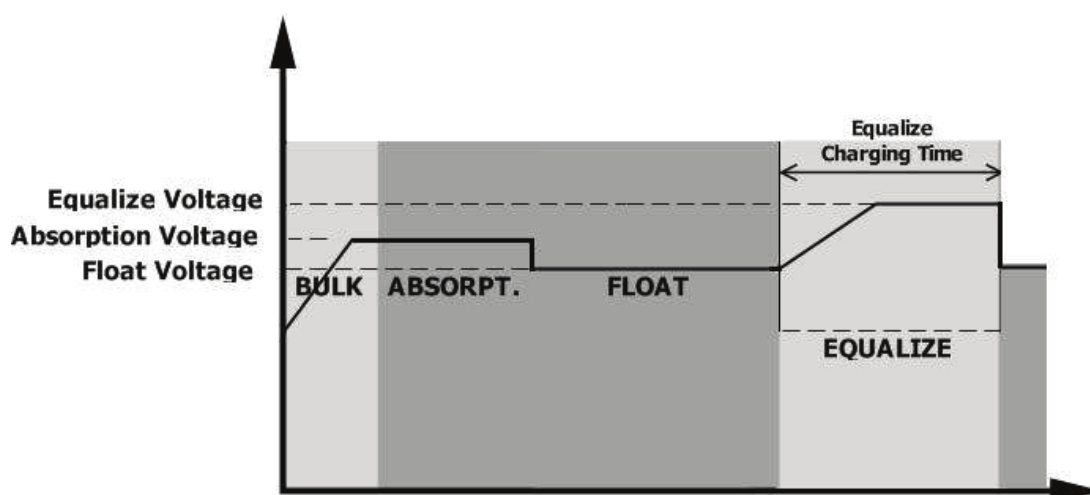

However, in Equalize stage, when battery equalized time is expired and battery voltage doesn't rise to battery equalization voltage point, the charge controller will extend the battery equalized time until battery voltage achieves battery equalization voltage. If battery voltage is still lower than battery equalization voltage when battery equalized timeout setting is over, the charge controller will stop equalization and return to float stage.

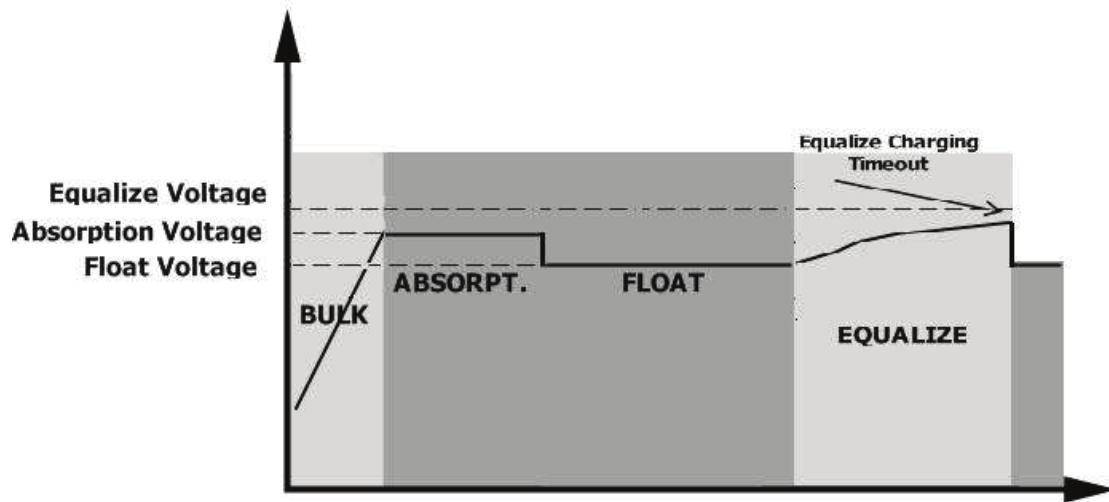

# SETTING FOR LITHIUM BATTERY

## Lithium Battery Connection

If choosing lithium battery for the inverter, you are allowed to use the lithium battery only which we have configured. There're two connectors on the lithium battery, RS485 port of BMS and power cable.

Please follow below steps to implement lithium battery connection:

- 1). Assemble battery terminal based on recommended battery cable and terminal size (same as Lead acid, see section Lead-acid Battery connection for details).
- 2). Connect the end of RS485 port of battery to BMS(RS485) communication port of inverter.

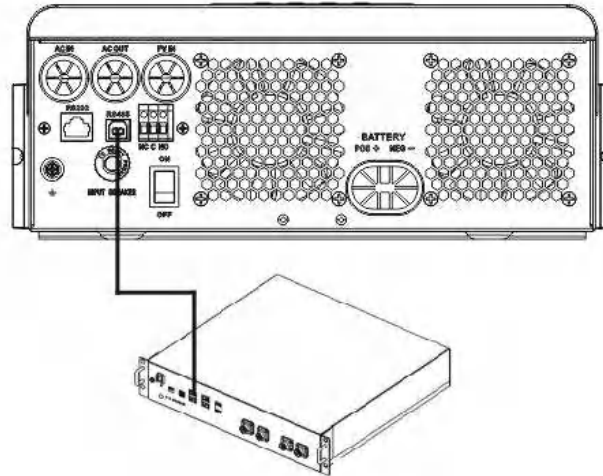

### Lithium battery communication and setting

if choosing lithium battery, make sure to connect the BMS communication cable between the battery and the inverter. This communication cable delivers information and signal between lithium battery and the inverter. This information is listed below:

- Re-configure charging voltage, charging current and battery discharge cut-off voltage according to the lithium battery parameters.
- Have the inverter start or stop charging according to the status of lithium battery.

### Connect the end of RS485 of battery to RS485 communication port of inverter

Make sure the lithium battery RS485 port connects to the inverter is Pin to Pin, the communication cable is inside of package and the inverter RS485 port pin assignment shown as below:

Pin number	RS485 Port	Wire color
PIN1	RS485-B	Red
PIN2	RS485-A	White
PIN3	GND	Green
PIN4	GND	Yellow
PIN5	NC	NC

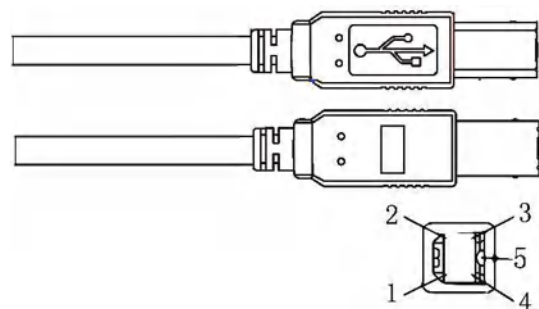

## LCD setting

After connecting, you need to finish and confirm some settings as follow:



Program	Description	Selectable option	
05	Battery type	05 AGM	AGM (default)
		05 FLd	Flooded
		05 USE	User-Defined
		05 LI 1	Standard communication Protocol from inverter supplier
		05 LI 2	Support PYLON US2000 Protocol
		05 LI 3	Customized Protocol
		05 LI 4	Customized Protocol(Priority)
43	Setting SOC point back to utility source when selecting "SBU priority" or "Solar first" in program 01	43 BAT 050%	Default 50%, 20%~50% Settable
		44 BAT 095%	Default 95%, 60%~100% Settable

**Note:** Program 43/44/45 are only available with successful communication, they will replace the Program 12/13/29 function, at the same time, program 12/13/29 become unavailable.

## LCD Display

If communication between the inverter and battery is successful, there is some information showing on the LCD as follow:

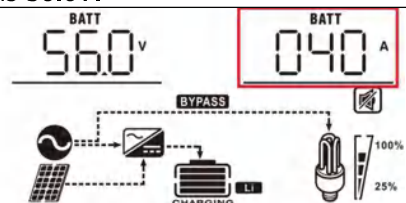
Item	Description	LCD display
1	Communication successful icon	<p>will be flashing</p>
2	Max lithium battery charging voltage	

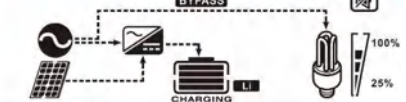
		Max lithium battery charging voltage is 56.0V.
3	Max lithium battery charging current	 <p>Max lithium battery charging current is 40A.</p>
4	Lithium battery discharging is forbidden	<b>Li</b> will flash once every 1 second
5	Lithium battery charging is forbidden	<b>Li</b> will flash once every 2 second
6	Lithium battery SOC(AH)	
7	Lithium battery SOC(%)	 <p>Lithium battery SOC is 63AH and 60%</p>

### Setting for PYLON US2000 lithium battery

1). PYLONTECH US2000 lithium battery setting:

Dip Switch: There are 4 Dip Switches that sets different baud rate and battery group address. If switch position is turned to the "OFF" position, it means "0". If switch position is turned to the "ON" position, it means "1".

Dip 1 is "ON" to represent the baud rate 9600.

Dip 2, 3 and 4 are reserved for battery group address.

Dip switch 2, 3 and 4 on master battery (first battery) are to set up or change the group address.

**NOTE:** "1" is upper position and "0" is bottom position.

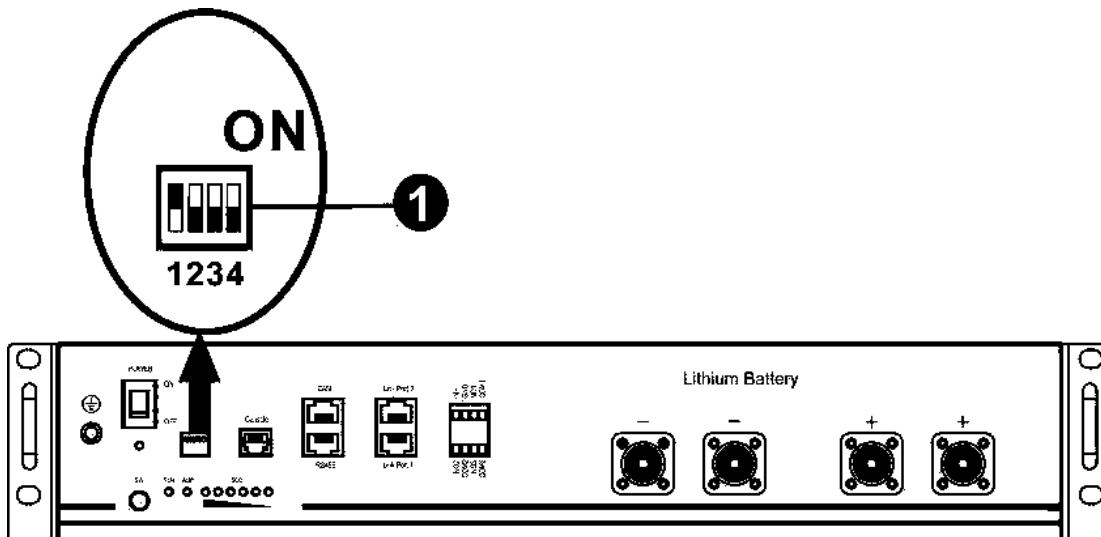

2). Process of install

Step 1. Use the RS485 cable to connect inverter and Lithium battery as Fig 1.

Step 2. Switch on Lithium battery.

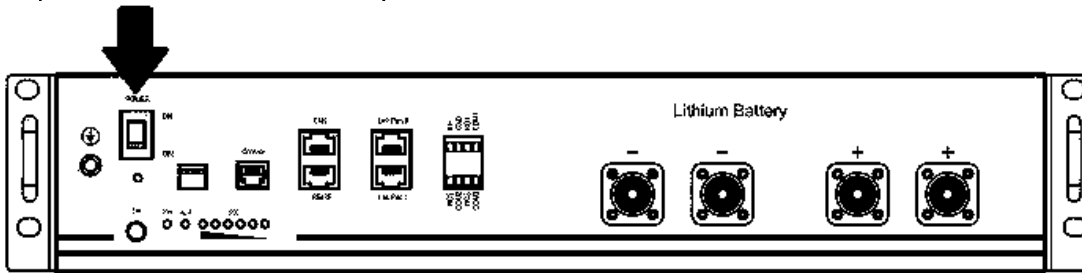

Step 3. Press more than three seconds to start Lithium battery, power output ready.

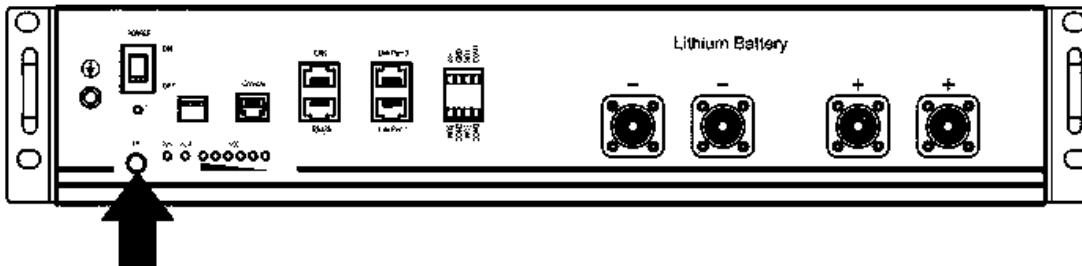

Step 4. Turn on the inverter.

Step 5. Be sure to select battery type as "Li2" in LCD program 5.

If communication between the inverter and battery is successful, the battery icon **Li** on LCD display will light

**Setting for lithium battery without communication**

This suggestion is used for lithium battery application and avoid lithium battery BMS protection without communication, please finish the setting as follow:

1. Before starting setting, you must get the battery BMS specification:

- A. Max charging voltage
- B. Max charging current
- C. Discharging protection voltage

2. Set battery type as "USE" (user-defined)

05	Battery type	AGM (default) 05 AGM	Flooded 05 FLd
		<b>User-Defined</b> 05 USE	If "User-Defined" is selected, battery charge voltage and low DC cut-off voltage can be set up in program 26, 27 and 29.

3. Set C.V voltage as Max charging voltage of BMS-**0.5V**.

26	Bulk charging voltage (C.V voltage)	default setting: 56.4V CU 26 56.4 <sup>BATT</sup> v
		If self-defined is selected in program 5, this program can be set up. Setting range is from 24.0V to 31.0V for 24v model and 48.0V to 62.0V for 48v model. But the setting value must be more than or equal the value of program 27. Increment of each click is 0.1V.



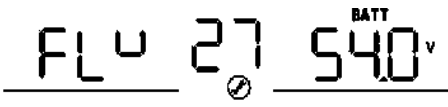

4. Set floating charging voltage as C.V voltage.

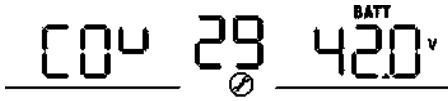
27	Floating charging voltage	default setting: 54.0V 
		If self-defined is selected in program 5, this program can be set up. Setting range is from 24.0V to the value of program 26 for 24v model and 48.0V to the value of program 26 for 48v model. Increment of each click is 0.1V.

5. Set Low DC cut-off voltage  $\geq$ discharging protection voltage of BMS+2V.

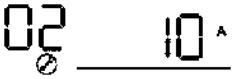
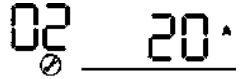
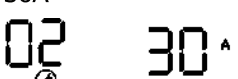
29	Low DC cut-off voltage	default setting: 42.0V 
		If self-defined is selected in program 5, this program can be set up. Setting range is from 20.0V to 27.0V for 24v model and 40.0V to 54.0V for 48v model. The setting value must be less than the value of program12. Increment of each click is 0.1V.Low DC cut-off voltage will be fixed to setting value no matter what percentage of load is connected.

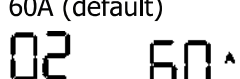
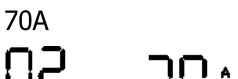
6. Set Max charging current which must be less than the Max charging current of BMS.

02	Maximum charging current: To configure total charging current for solar and utility chargers. (Max. charging current = utility charging current + solar charging current)	10A 	20A 
		30A 	40A 
		50A 	60A (default) 
		70A 	80A 

7. Setting voltage point back to utility source when selecting "SBU priority" or "Solar first" in program 01.The setting value must be  $\geq$ Low DC cut-off voltage+1V, or else the inverter will have a warning as battery voltage low.

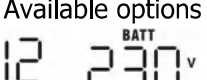
12	Setting voltage point back to utility source when selecting "SBU priority" or "Solar first" in program 01.	Available options in 48V models: 46V (default) 
		Available options in 24V models: 23V (default) 

Remark:

- 1.you'd better to finish setting without turn on the inverter(just let the LCD show, no output);
- 2.when you finish setting, please restart the inverter.

# SPECIFICATIONS

## Table 1 Line Mode Specifications

INVERTER MODEL	ES-3524S	ES-5548PL
<b>Input Voltage Waveform</b>	Sinusoidal (utility or generator)	
<b>Nominal Input Voltage</b>	230Vac	
<b>Low Loss Voltage</b>	170Vac±7V (UPS) 90Vac±7V (Appliances)	
<b>Low Loss Return Voltage</b>	180Vac±7V (UPS); 100Vac±7V (Appliances)	
<b>High Loss Voltage</b>	280Vac±7V	
<b>High Loss Return Voltage</b>	270Vac±7V	
<b>Max AC Input Voltage</b>	300Vac	
<b>Nominal Input Frequency</b>	50Hz / 60Hz (Auto detection)	
<b>Low Loss Frequency</b>	40±1Hz	
<b>Low Loss Return Frequency</b>	42±1Hz	
<b>High Loss Frequency</b>	65±1Hz	
<b>High Loss Return Frequency</b>	63±1Hz	
<b>Output Short Circuit Protection</b>	Line mode: Circuit Breaker Battery mode: Electronic Circuits	
<b>Efficiency (Line Mode)</b>	>95% ( Rated R load, battery full charged )	
<b>Transfer Time</b>	10ms typical (UPS); 20ms typical (Appliances)	
<p><b>Output power derating:</b> When AC input voltage drops to 95V or 170V depending on models, the output power will be derated.</p>		



**Table 2 Inverter Mode Specifications**

INVERTER MODEL	ES-3524S	ES-5548PL
<b>Rated Output Power</b>	3.5KVA/3.5KW	5.5KVA/5.5KW
<b>Output Voltage Waveform</b>	Pure Sine Wave	
<b>Output Voltage Regulation</b>	230Vac±5%	
<b>Output Frequency</b>	60Hz or 50Hz	
<b>Peak Efficiency</b>	94%	
<b>Overload Protection</b>	5s@≥140% load; 10s@100%~140% load	
<b>Surge Capacity</b>	2* rated power for 5 seconds	
<b>Nominal DC Input Voltage</b>	24Vdc	48Vdc
<b>Cold Start Voltage</b>	23.0Vdc	46.0Vdc
<b>Low DC Warning Voltage</b> @ load < 20% @ 20% ≤ load < 50% @ load ≥ 50%	22.0Vdc 21.4Vdc 20.2Vdc	44.0Vdc 42.8Vdc 40.4Vdc
<b>Low DC Warning Return Voltage</b> @ load < 20% @ 20% ≤ load < 50% @ load ≥ 50%	23.0Vdc 22.4Vdc 21.2Vdc	46.0Vdc 44.8Vdc 42.4Vdc
<b>Low DC Cut-off Voltage</b> @ load < 20% @ 20% ≤ load < 50% @ load ≥ 50%	21.0Vdc 20.4Vdc 19.2Vdc	42.0Vdc 40.8Vdc 38.4Vdc

### Table 3 Charge Mode Specifications

Utility Charging Mode		
<b>INVERTER MODEL</b>	<b>ES-3524S</b>	<b>ES-5548PL</b>
<b>Max Charging Current (PV+AC)</b>	100Amp (@ $V_{I/P}=230V_{ac}$ )	
<b>MaxCharging Current (AC)</b>	60Amp (@ $V_{I/P}=230V_{ac}$ )	
<b>Bulk Charging Voltage</b>	<b>Flooded Battery</b>	29.2Vdc
	<b>AGM / Gel Battery</b>	28.2Vdc
<b>Floating Charging Voltage</b>	27Vdc	54Vdc
<b>Overcharge Protection</b>	33Vdc	63Vdc
<b>Charging Algorithm</b>	3-Step	
<b>Charging Curve</b>	<p>The graph illustrates the 3-step charging process. The left y-axis represents Battery Voltage per cell, and the right y-axis represents Charging Current (%). The x-axis represents Time. The process starts in the Bulk phase (Constant Current) at 100% current, rising to a peak voltage of 2.43Vdc (2.35Vdc). It then enters the Absorption phase (Constant Voltage), where the current decreases as the voltage remains constant. The time for this phase is T1 = 10 * T0, with a minimum of 10 minutes and a maximum of 8 hours. Finally, it enters the Maintenance phase (Floating), where the current continues to decrease and the voltage stabilizes at 2.25Vdc.</p>	
Solar Input		
<b>INVERTER MODEL</b>	<b>ES-3524S</b>	<b>ES-5548PL</b>
<b>Rated Power</b>	4000W	5500W
<b>Max. PV Array Open Circuit Voltage</b>	500Vdc	
<b>PV Array MPPT Voltage Range</b>	120Vdc~450Vdc	
<b>Max. Input Current</b>	15A	18A
<b>MaxCharging Current(PV)</b>	100A	

### Table 4 General Specifications

<b>INVERTER MODEL</b>	<b>ES-3524S</b>	<b>ES-5548PL</b>
<b>Safety Certification</b>	CE	
<b>Operating Temperature Range</b>	-10°C to 55°C	
<b>Storage temperature</b>	-15°C~ 60°C	
<b>Humidity</b>	5% to 95% Relative Humidity (Non-condensing)	
<b>Dimension (D*W*H), mm</b>	420*295*121mm	
<b>Net Weight, kg</b>	8.2(8.5)	9.9(10.2)

# TROUBLE SHOOTING

Problem	LCD/LED/Buzzer	Explanation / Possible cause	What to do
Unit shuts down automatically during startup process.	LCD/LEDs and buzzer will be active for 3 seconds and then complete off.	The battery voltage is too low	1. Re-charge battery. 2. Replace battery.
No response after power on.	No indication.	1. The battery voltage is far too low. 2. Battery polarity is connected reversed.	1. Check if batteries and the wiring are connected well. 2. Re-charge battery. 3. Replace battery.
Mains exist but the unit works in battery mode.	Input voltage is displayed as 0 on the LCD and green LED is flashing.	Input protector is tripped	Check if AC breaker is tripped and AC wiring is connected well.
	Green LED is flashing.	Insufficient quality of AC power. (Shore or Generator)	1. Check if AC wires are too thin and/or too long. 2. Check if generator (if applied) is working well or if input voltage range setting is correct. (UPS→Appliance)
	Green LED is flashing.	Set "Solar First" as the priority of output source.	Change output source priority to Utility first.
When the unit is turned on, internal relay is switched on and off repeatedly.	LCD display and LEDs are flashing	Battery is disconnected.	Check if battery wires are connected well.
Buzzer beeps continuously and red LED is on.	Fault code 07	Overload error. The inverter is overload 110% and time is up.	Reduce the connected load by switching off some equipment.
	Fault code 05	Output short circuited.	Check if wiring is connected well and remove abnormal load.
	Fault code 02	Internal temperature of inverter component is over 100°C.	Check whether the air flow of the unit is blocked or whether the ambient temperature is too high.
	Fault code 03	Battery is over-charged.	Return to repair center.
		The battery voltage is too high.	Check if spec and quantity of batteries are meet requirements.
	Fault code 06/22	Output abnormal (Inverter voltage below than 190Vac or is higher than 260Vac)	1. Reduce the connected load. 2. Return to repair center
	Fault code 08/09/15	Internal components failed.	Return to repair center.
	Fault code 13	Over current or surge.	Restart the unit, if the error happens again, please return to repair center.
	Fault code 14	Bus voltage is too low.	
	Fault code 16	Output voltage is unbalanced.	
Another fault code		If the wires is connected well, please return to repair center.	

# Parallel Installation Guide

## 1. Instruction

This inverter can be used in parallel with two different operation modes.

1. Parallel operation in single phase with up to 12 units. The supported maximum output power is 66KW/66KVA.
2. Maximum 12 units work together to support three-phase equipment. 10 units support one phase maximum. The supported maximum output power is 66KW/66KVA and one phase can be up to 55KW/55KVA.

**NOTE:** If this unit is bundled with share current cable and parallel cable, this inverter is default supported parallel operation.

## 2. Package Contents

In parallel kit, you will find the following items in the package:

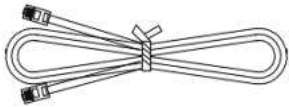

Parallel communication cable

## 3. Mounting the Unit

When installing multiple units, please follow below chart.

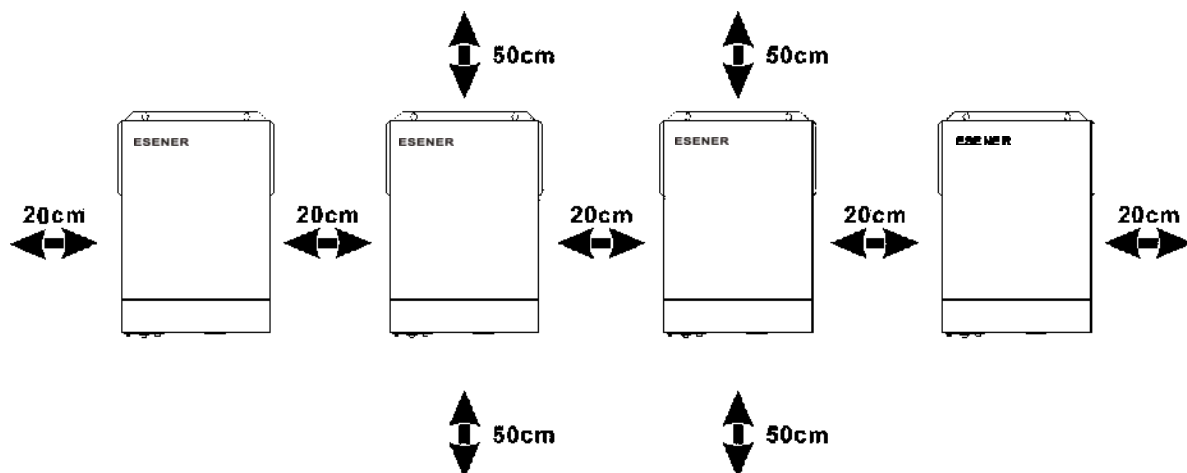

**NOTE:** For proper air circulation to dissipate heat, allow a clearance of approx. 20 cm to the side and approx. 50 cm above and below the unit. Be sure to install each unit in the same level.

## 4. Wiring Connection

**NOTICE: It's requested to connect to battery for parallel operation.**

The cable size of each inverter is shown as below:

Recommended battery cable and terminal size for each inverter:

Model	Wire Size	Cable mm <sup>2</sup>	Dimensions		Torque value
			L1 (mm)	L2 (mm)	
5.5KVA	2AWG	38	3	18	2~ 3 Nm

**Stripping Length:**

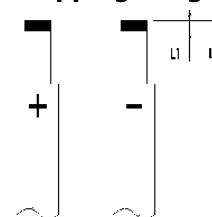

**WARNING:** Be sure the length of all battery cables is the same. Otherwise, there will be voltage difference between inverter and battery to cause parallel inverters not working.

Recommended AC input and output cable size for each inverter:

Model	AWG no.	Torque
5.5KVA	8 AWG	1.4~1.6Nm

You need to connect the cables of each inverter together. Take the battery cables for example: You need to use a connector or bus-bar as a joint to connect the battery cables together, and then connect to the battery terminal. The cable size used from joint to battery should be X times cable size in the tables above. "X" indicates the number of inverters connected in parallel.

Regarding AC input and output, please also follow the same principle.

**CAUTION!!** Please install the breaker at the battery and AC input side. This will ensure the inverter can be securely disconnected during maintenance and fully protected from over current of battery or AC input. The recommended mounted location of the breakers is shown in the figures in Point 5.

Recommended breaker specification of battery for each inverter:

Model	1 unit*
5.5KVA	100A/60VDC

\*If you want to use only one breaker at the battery side for the whole system, the rating of the breaker should be X times current of 1 unit. "X" indicates the number of inverters connected in parallel.

Recommended breaker specification of AC input with single phase:

Model	2 units	3 units	4 units	5 units	6 units	7 units	8 units	9 units	10 units	11 units	12 units
5.5KVA	100A	150A	200A	250A	300A	350A	400A	450A	500A	550A	600A

**Note1:** Also, you can use 40A breaker (50A for 5.5KVA) for only 1 unit, and each inverter has a breaker at its AC input.

Recommended battery capacity

Inverter parallel numbers	2	3	4	5	6	7	8	9	10	11	12
Battery Capacity	400AH	600AH	800AH	1000AH	1200AH	1400AH	1600AH	1800AH	2000AH	2200AH	2400AH

**WARNING!** Be sure that all inverters will share the same battery bank. Otherwise, the inverters will transfer to fault mode.

**Communicating with battery BMS in parallel system**

- 1) Only support common battery installation
- 2) Use RJ45 cable to connect any one of inverters (no need to connect to a specific inverter) and Lithium battery.

Simply set this inverter battery type to "Li 2" in LCD program 5. Others should be default value "AGM".

**Note:** Make sure only one inverter is connected RJ45 cable and only the one is set as Lithium in LCD program 5.

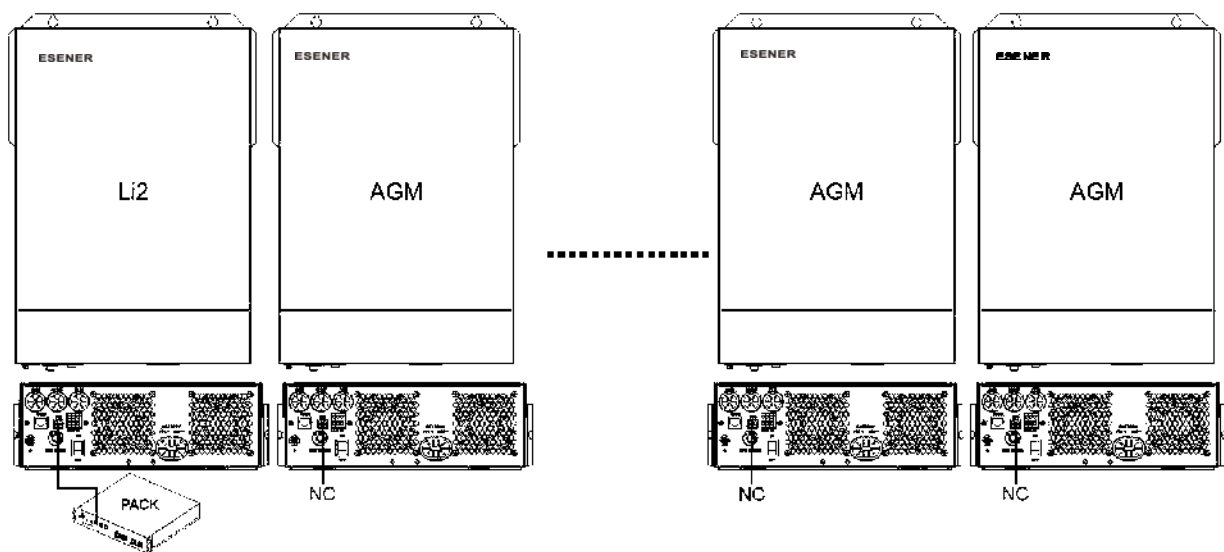

## 5. Parallel Operation in Single phase

Two inverters in parallel:

### Power Connection

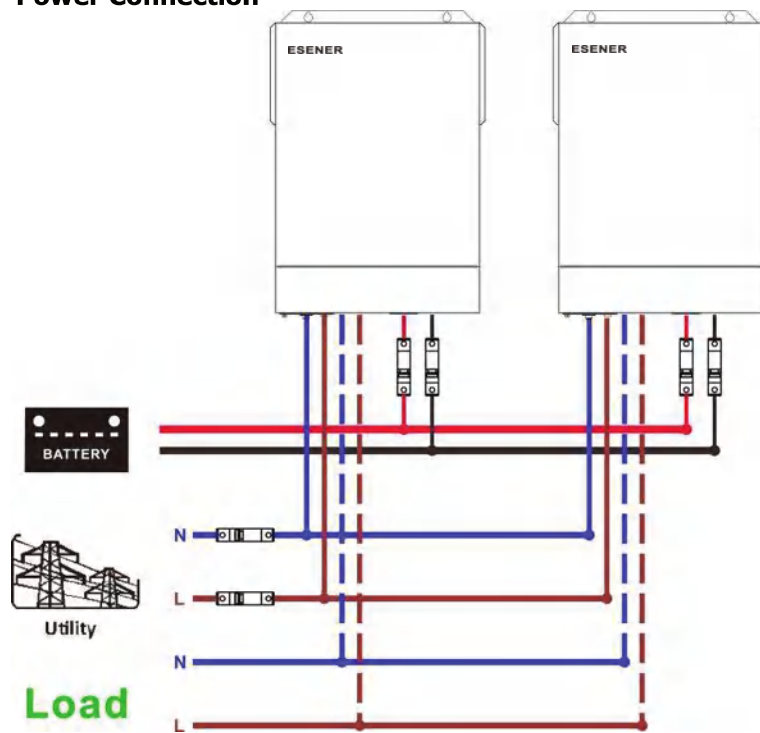

### Communication Connection



Three inverters in parallel:

### Power Connection

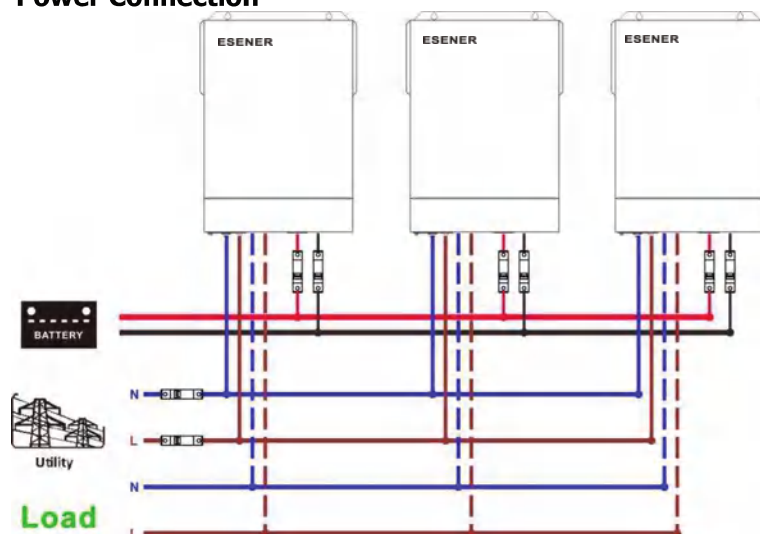

**Communication Connection**

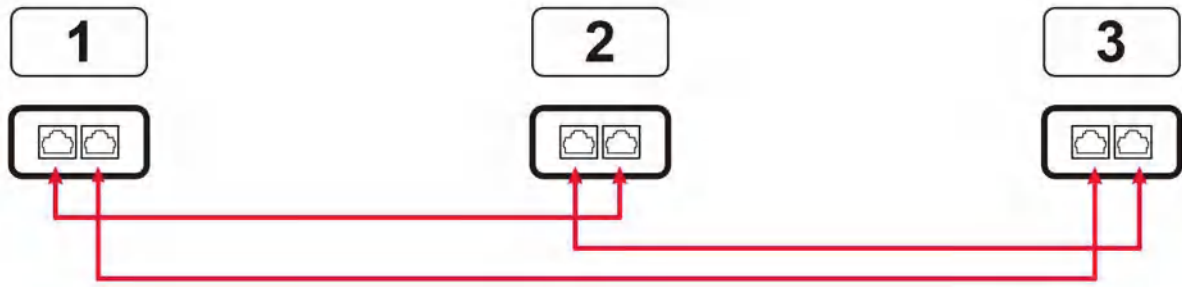

Four inverters in parallel:

**Power Connection**

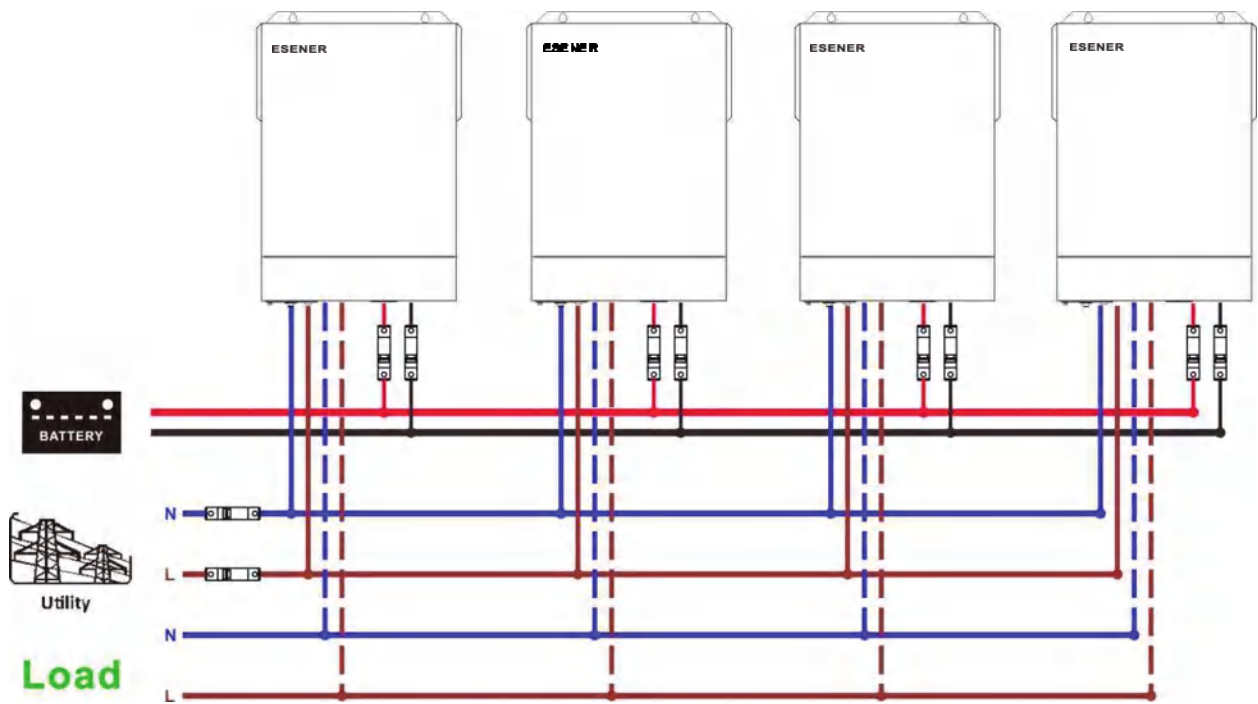

**Communication Connection**

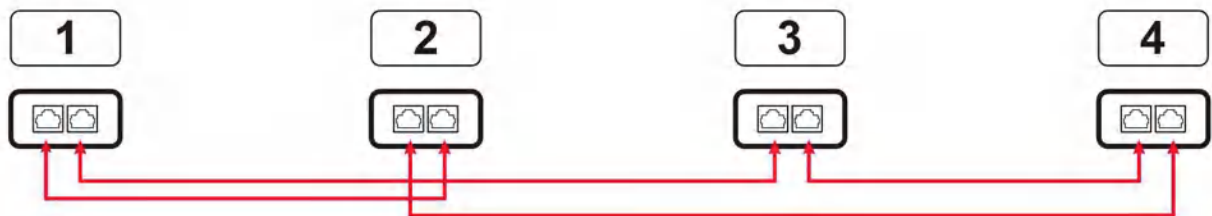



Five inverters in parallel:

**Power Connection**

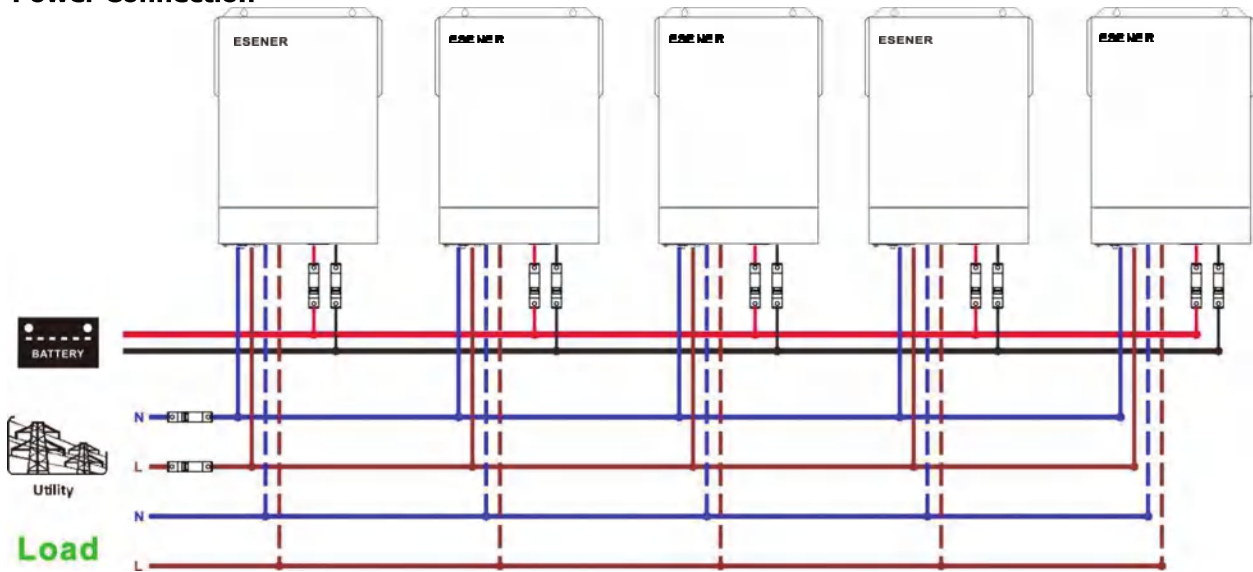

**Communication Connection**

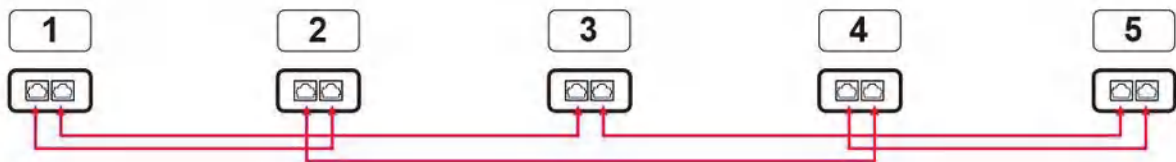

Six inverters in parallel:

**Power Connection**

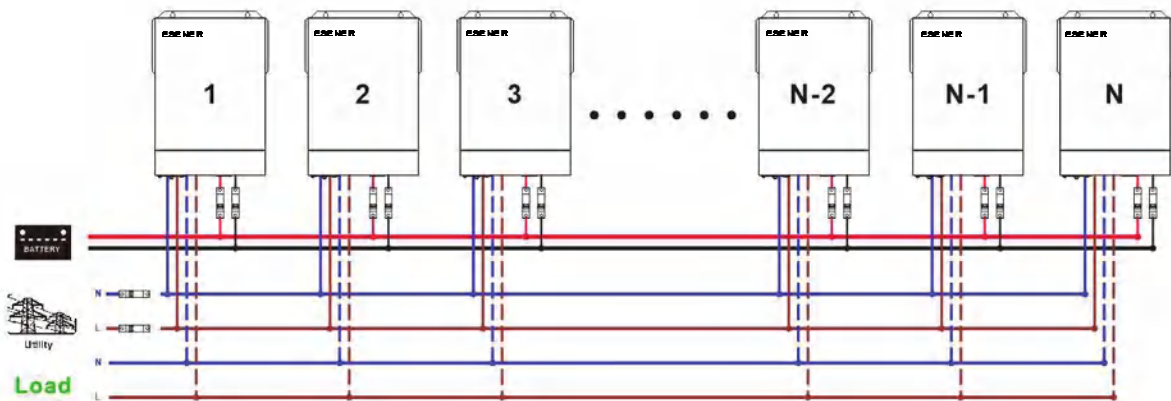

**Communication Connection**



**Note:**  $N_{max}=12$ units.

## 6. Support 3-phase equipment

One inverter in each phase:

### Power Connection

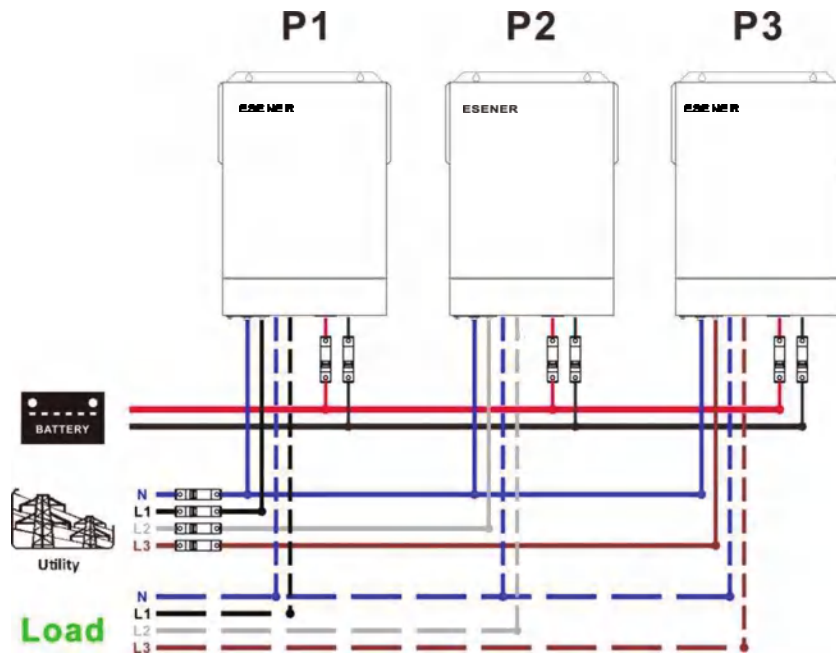

### Communication Connection

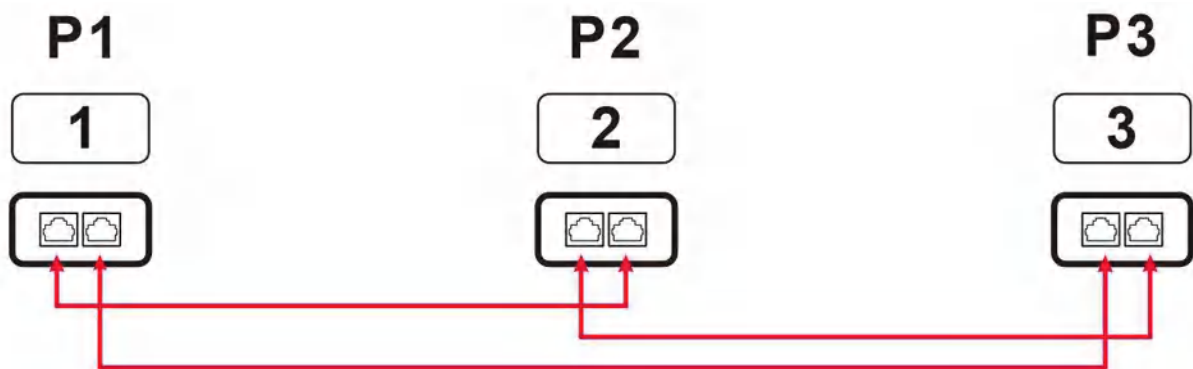

Three inverters in each phase:

### Power Connection

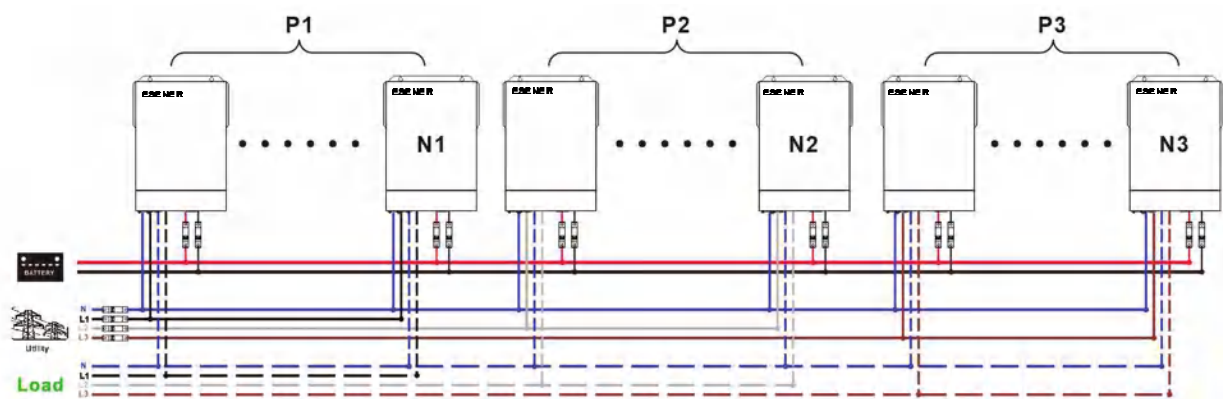

**Note:** It's up to customer's demand to pick **10** inverters on any phase.

P1: L1-phase, P2: L2-phase, P3: L3-phase.

**$N = N1 + N2 + N3, N_{max} = 12 \text{ units}$**

**$N1_{max}=10$  units is in one phase and one inverter for the other two phases ( $N2=N3=1$ ) :**

**Power Connection**

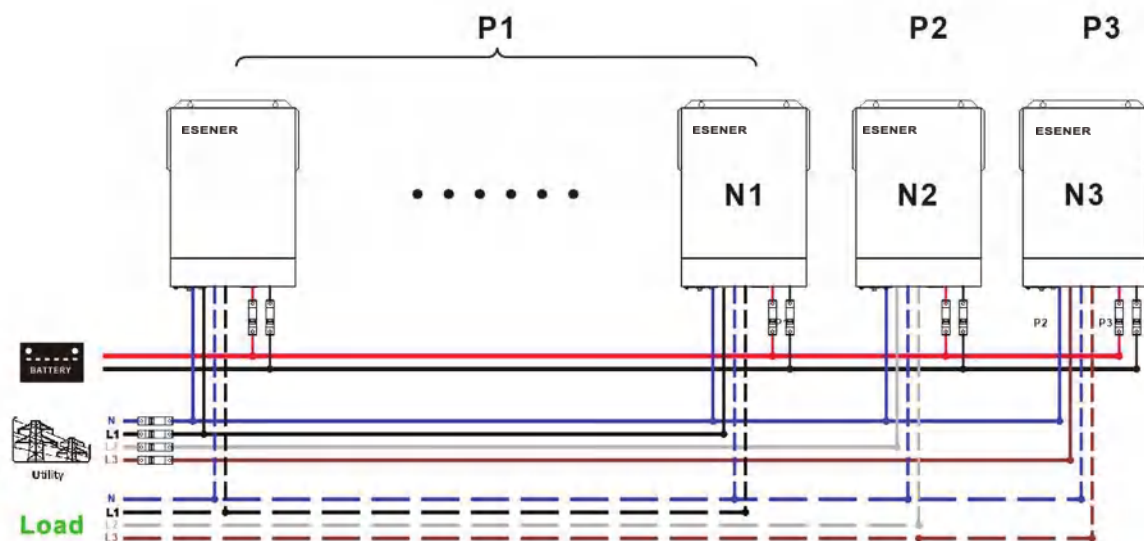

**Note:** It's up to customer's demand to pick 7 inverters on any phase.

P1: L1-phase, P2: L2-phase, P3: L3-phase.

**$N=N1+N2+N3, N_{max}=12$  units**

**$N1_{max}= N2_{max} =9$  units is in two phases and one inverter for the one phase ( $N3=1$ ) :**

**Power Connection**

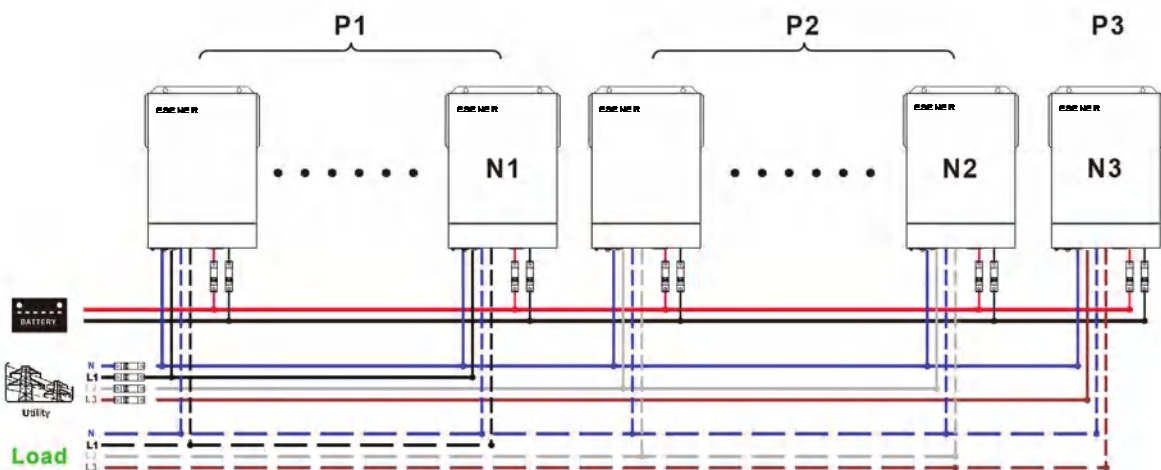

**Communication Connection**

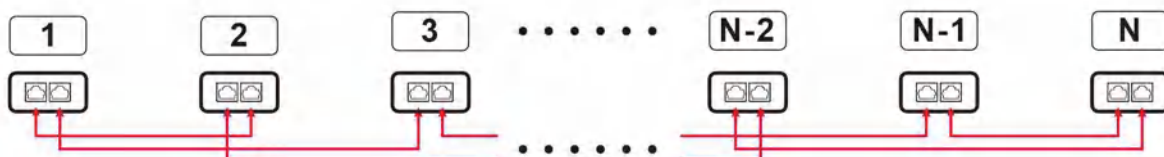

## 7. PV Connection





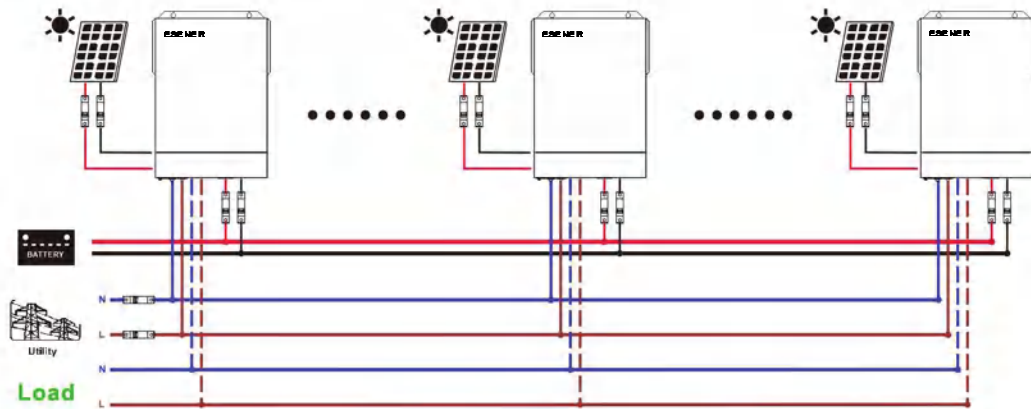

Please refer to user manual of single unit for PV Connection.

**CAUTION:** Each inverter should connect to PV modules separately.

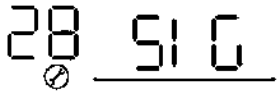
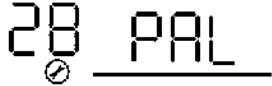

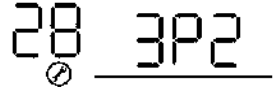
## 8. LCD Setting and Display

### Setting Program:

Program	Description	Selectable option	
28	AC output mode	Single: This inverter is used in single phase application. 	Parallel: This inverter is operated in parallel system. (Need hardware support) 
		L1 phase 	The inverter is operated in L1 phase in 3-phase application
		L2 phase 	The inverter is operated in L2 phase in 3-phase application
		L3 phase 	The inverter is operated in L3 phase in 3-phase application
30	PV judge condition (Only apply for setting "Solar first" in program 1: Output source priority)	One Inverter (Default): 	When "ONE" is selected, as long as one of inverters has been connected to PV modules and PV input is normal, parallel or 3-phase system will continue working according to rule of "solar first" setting. For example, two units are connected in parallel and set "SOL" in output source priority. If one of two units has connected to PV modules and PV input is normal, the parallel system will provide power to loads from solar or battery power. If both of them are not sufficient, the system will provide power to loads from utility.
		All of Inverters: 	When "ALL" is selected, parallel or 3-phase system will continue working according to rule of "solar first" setting only when all of inverters are connected to PV modules. For example, two units are connected in parallel and set "SOL" in output source priority. When selecting "ALL" in program 30, it's necessary to have all inverters connected to PV modules and PV input is normal to allow the system to provide power to loads from solar and battery power. Otherwise, the system will provide power to loads from utility.

**Fault code display:**

Fault Code	Fault Event	Icon on
24	Host loss	
25	Synchronization loss	
26	Incompatible battery type	
27	Firmware version inconsistent	

**Warning code display:**

Warning Code	Warning Event	Icon on
16	CAN communication loss	
17	AC output mode setting is different	
18	Battery voltage detected different	

## 9. Commissioning

### Parallel in single phase



Step 1: Check the following requirements before commissioning:

- Correct wire connection
- Ensure all breakers in Line wires of load side are open and each Neutral wires of each unit are connected together.

Step 2: Turn on each unit and set "PAL" in LCD setting program 28 of each unit. And then shut down all units. **NOET:** It's necessary to turn off switch when setting LCD program. Otherwise, the setting can not be programmed.

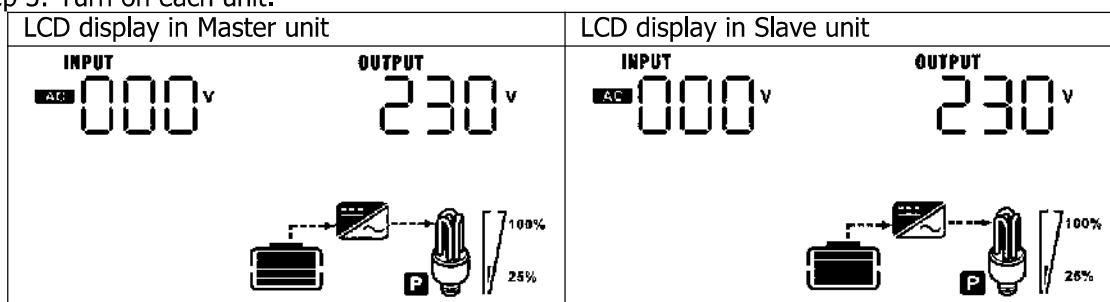
Step 3: Turn on each unit.



**NOTE:** Master and slave units are randomly defined. If it is master the icon  blinks, if it is slave the icon  normally on.

Step 4: Switch on all AC breakers of Line wires in AC input. It's better to have all inverters connect to utility at the same time. If detecting AC connection, they will work normally.

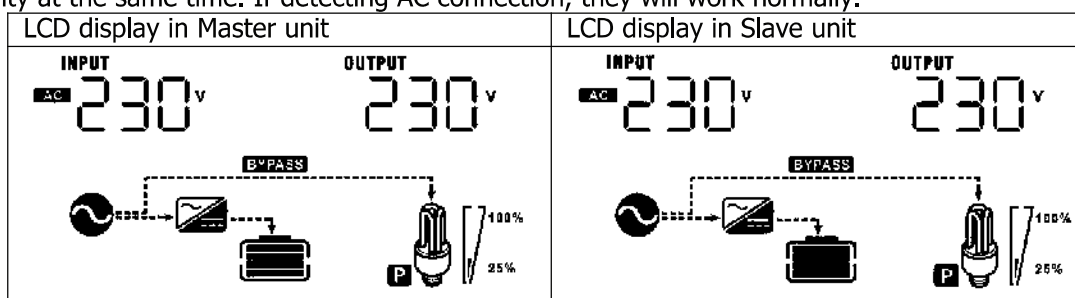

Step 5: If there is no more fault alarm, the parallel system is completely installed.

Step 6: Please switch on all breakers of Line wires in load side. This system will start to provide power to the load.

## 10. Trouble shooting

Situation		Solution
Fault Code	Fault Event Description	
24	Host data loss	<ol style="list-style-type: none"> <li>1. Check if communication cables are connected well and restart the inverter.</li> <li>2. If the problem remains, please contact your installer.</li> </ol>
25	Synchronization data loss	<ol style="list-style-type: none"> <li>3. Check if communication cables are connected well and restart the inverter.</li> <li>1. If the problem remains, please contact your installer.</li> </ol>
26	Incompatible battery type	<ol style="list-style-type: none"> <li>1. Check the battery type setting to ensure that only the device connected to the BMS in the system is one of Li1 or Li2 or Li3</li> <li>2. If the problem remains, please contact your installer.</li> </ol>
27	Firmware version inconsistent	<ol style="list-style-type: none"> <li>1. Update all inverter firmware to the same version.</li> <li>2. Check the version of each inverter via LCD setting and make sure the CPU versions are same. If not, please contact your instraller to provide the firmware to update.</li> <li>3. After updating, if the problem still remains, please contact your installer.</li> </ol>

Situation		Solution
Warning Code	Warning Event Description	
16	CAN communication loss	<ol style="list-style-type: none"> <li>1. Check if communication cables are connected well and restart the inverter.</li> <li>2. If the problem remains, please contact your installer.</li> </ol>
17	AC output mode setting is different.	<ol style="list-style-type: none"> <li>1. Switch off the inverter and check LCD setting #28.</li> <li>2. For parallel system in single phase, make sure "PAL" is set on #28.</li> <li>3. If the problem remains, please contact your installer.</li> </ol>
18	The battery voltage of each inverter is not the same.	<ol style="list-style-type: none"> <li>1. Make sure all inverters share same groups of batteries together.</li> <li>2. Remove all loads and disconnect AC input and PV input. Then, check battery voltage of all inverters. If the values from all inverters are close, please check if all battery cables are the same length and same material type. Otherwise, please contact your installer to provide SOP to calibrate battery voltage of each inverter.</li> <li>3. If the problem still remains, please contact your installer.</li> </ol>

# Wi-Fi Plug Pro

## Quick Installation Guideline

### P. Packing Accessories Detail

P-1 WIFI Modular; P-2 Communication cable; P-3 Instruction book;



P-1

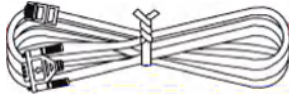

P-2



P-3

### 1. Installation Steps

1.1 Plug antenna into WIFI box body;



1.2 Plug communication cable into WIFI Modular ;

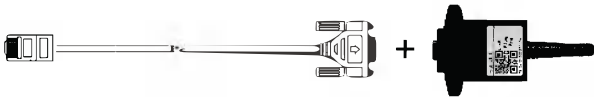

1.3 Plug the communication cable RJ45 head into the inverter RS232 port( RJ45 Port Type);

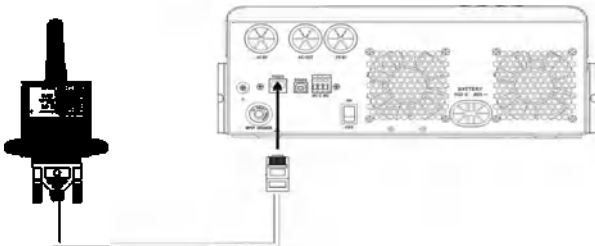

### 2. Wireless Router Connection

2.1 Download APP

① Scan the QR Code on the right side and download the APP.



SmartESS(iOS)



SmartESS(Android)

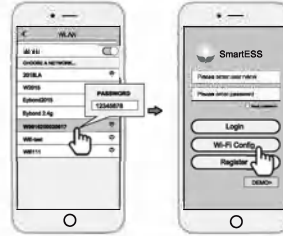

2.2 Connect Wi-Fi Datalogger

① Select the same number of Wi-Fi Plug Pro PN to connect on your phone WLAN.  
(InitialPassword:12345678)  
② Open the APP, tap the **Wi-Fi Config** button to enter this page.

2.3 Network Setting

① Then tap the Network Setting button.  
② According to the prompts, type in the information to finish the network setting.  
③ After the Wi-Fi Plug Pro is restarted, reconnect the Wi-Fi which connected by step 2.1.

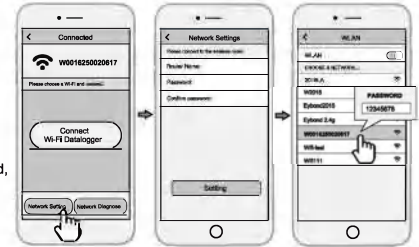

### 3. Create Account And Add Datalogger

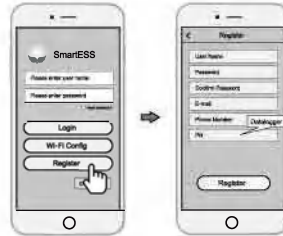

3.1 Create Account

① Open the APP, tap the **Register** button to enter this page.  
② According to the prompts, type in the information to create an account.

3.2 Add Datalogger

① Login the account and click the **Datalogger** button. Tap the "+" button on the top-right corner of the **Datalogger** page.  
② Scan the PN on the Wi-Fi Plug Pro, or input it manually.  
③ According to the prompts, type in the information to finish add datalogger.

